

MX269020A
LTE Downlink Measurement
Software
Operation Manual
Operation

25th Edition

- For safety and warning information, please read this manual before attempting to use the equipment.
- Additional safety and warning information is provided within the MS2690A/MS2691A/MS2692A Signal Analyzer Operation Manual (Mainframe Operation) or MS2830A Signal Analyzer Operation Manual (Mainframe Operation). Please also refer to this document before using the equipment.
- Keep this manual with the equipment.

ANRITSU CORPORATION

Safety Symbols

To prevent the risk of personal injury or loss related to equipment malfunction, Anritsu Corporation uses the following safety symbols to indicate safety-related information. Ensure that you clearly understand the meanings of the symbols BEFORE using the equipment. Some or all of the following symbols may be used on all Anritsu equipment. In addition, there may be other labels attached to products that are not shown in the diagrams in this manual.

Symbols used in manual

 **DANGER** This indicates a very dangerous procedure that could result in serious injury or death if not performed properly.

 **WARNING** This indicates a hazardous procedure that could result in serious injury or death if not performed properly.

 **CAUTION** This indicates a hazardous procedure or danger that could result in light-to-severe injury, or loss related to equipment malfunction, if proper precautions are not taken.

Safety Symbols Used on Equipment and in Manual

The following safety symbols are used inside or on the equipment near operation locations to provide information about safety items and operation precautions. Ensure that you clearly understand the meanings of the symbols and take the necessary precautions BEFORE using the equipment.



This indicates a prohibited operation. The prohibited operation is indicated symbolically in or near the barred circle.



This indicates an obligatory safety precaution. The obligatory operation is indicated symbolically in or near the circle.



This indicates a warning or caution. The contents are indicated symbolically in or near the triangle.



This indicates a note. The contents are described in the box.



These indicate that the marked part should be recycled.

MX269020A
LTE Downlink Measurement Software
Operation Manual Operation

29 October 2007 (First Edition)
23 June 2016 (25th Edition)

Copyright © 2007-2016, ANRITSU CORPORATION.

All rights reserved. No part of this manual may be reproduced without the prior written permission of the publisher.

The contents of this manual may be changed without prior notice.

Printed in Japan

Equipment Certificate

Anritsu Corporation guarantees that this equipment was inspected at shipment and meets the published specifications.

Anritsu Warranty

- During the warranty period, Anritsu Corporation will repair or exchange this software free-of-charge if it proves defective when used as described in the operation manual.
- The warranty period is 6 months from the purchase date.
- The warranty period after repair or exchange will remain 6 months from the original purchase date, or 30 days from the date of repair or exchange, depending on whichever is longer.
- This warranty does not cover damage to this software caused by Acts of God, natural disasters, and misuse or mishandling by the customer.

In addition, this warranty is valid only for the original equipment purchaser. It is not transferable if the equipment is resold.

Anritsu Corporation shall assume no liability for injury or financial loss of the customer due to the use of or a failure to be able to use this equipment.

Anritsu Corporation Contact

In the event that this equipment malfunctions, contact an Anritsu Service and Sales office. Contact information can be found on the last page of the printed version of this manual, and is available in a separate file on the CD version.

Notes On Export Management

This product and its manuals may require an Export License/Approval by the Government of the product's country of origin for re-export from your country.

Before re-exporting the product or manuals, please contact us to confirm whether they are export-controlled items or not.

When you dispose of export-controlled items, the products/manuals need to be broken/shredded so as not to be unlawfully used for military purpose.

Software End-User License Agreement (EULA)

Please read this Software End-User License Agreement (hereafter this EULA) carefully before using (includes executing, copying, registering, etc.) this software (includes programs, databases, scenarios, etc., used to operate, set, etc., Anritsu electronic equipment). By reading this EULA and using this software, you are agreeing to be bound by the terms of its contents and Anritsu Corporation (hereafter Anritsu) hereby grants you the right to use this Software with the Anritsu-specified equipment (hereafter Equipment) for the purposes set out in this EULA.

1. Grant of License and Limitations

1. Regardless of whether this Software was purchased from or provided free-of-charge by Anritsu, you agree not to rent, lease, lend, or otherwise distribute this Software to third parties and further agree not to disassemble, recompile, reverse engineer, modify, or create derivative works of this Software.
2. You may make one copy of this Software for backup purposes only.
3. You are not permitted to reverse engineer this software.
4. This EULA allows you to install one copy of this Software on one piece of Equipment.

2. Disclaimers

To the extent not prohibited by law, in no event shall Anritsu be liable for personal injury, or any incidental, special, indirect or consequential damages whatsoever, including, without limitation, damages for loss of profits, loss of data, business interruption or any other commercial damages or losses, arising out of or related to your use or inability to use this Software.

3. Limitation of Liability

- a. If a fault (bug) is discovered in this Software, preventing operation as described in the operation manual or specifications whether or not the customer uses this software as described in the manual, Anritsu shall at its own discretion, fix the bug, or exchange the software, or suggest a workaround, free-of-charge. However, notwithstanding the above, the following items shall be excluded from repair and warranty.
 - i) If this Software is deemed to be used for purposes not described in the operation manual or specifications.
 - ii) If this Software is used in conjunction with other non-Anritsu-approved software.
 - iii) Recovery of lost or damaged data.
 - iv) If this Software or the Equipment has been modified, repaired, or otherwise altered without Anritsu's prior approval.
 - v) For any other reasons out of Anritsu's direct control and responsibility, such as but not limited to, natural disasters, software virus infections, etc.
- b. Expenses incurred for transport, hotel, daily allowance, etc., for on-site repairs by Anritsu engineers necessitated by the above faults shall be borne by you.
- c. The warranty period for faults listed in article 3a above covered by this EULA shall be either 6 months from the date of purchase of this Software or 30 days after the date of repair, whichever is longer.

4. Export Restrictions

You may not use or otherwise export or re-export directly or indirectly this Software except as authorized by Japanese and United States law. In particular, this software may not be exported or re-exported (a) into any Japanese or US embargoed countries or (b) to anyone on the Japanese or US Treasury Department's list of Specially Designated Nationals or the US Department of Commerce Denied Persons List or Entity List. By using this Software, you warrant that you are not located in any such country or on any such list. You also agree that you will not use this Software for any purposes prohibited by Japanese and US law, including, without limitation, the development, design and manufacture or production of missiles or nuclear, chemical or biological weapons of mass destruction.

5. Termination

Anritsu shall deem this EULA terminated if you violate any conditions described herein. This EULA shall also be terminated if the conditions herein cannot be continued for any good reason, such as violation of copyrights, patents, or other laws and ordinances.

6. Reparations

If Anritsu suffers any loss, financial or otherwise, due to your violation of the terms of this EULA, Anritsu shall have the right to seek proportional damages from you.

7. Responsibility after Termination

Upon termination of this EULA in accordance with item 5, you shall cease all use of this Software immediately and shall as directed by Anritsu either destroy or return this Software and any backup copies, full or partial, to Anritsu.

8. Dispute Resolution

If matters of dispute or items not covered by this EULA arise, they shall be resolved by negotiations in good faith between you and Anritsu.

9. Court of Jurisdiction

This EULA shall be interpreted in accordance with Japanese law and any disputes that cannot be resolved by negotiation described in Article 8 shall be settled by the Japanese courts.

Cautions against computer virus infection

- Copying files and data
Only files that have been provided directly from Anritsu or generated using Anritsu equipment should be copied to the instrument.
All other required files should be transferred by means of USB or CompactFlash media after undergoing a thorough virus check.
- Adding software
Do not download or install software that has not been specifically recommended or licensed by Anritsu.
- Network connections
Ensure that the network has sufficient anti-virus security protection in place.

CE Conformity Marking

Anritsu affixes the CE conformity marking on the following product(s) in accordance with the Decision 768/2008/EC to indicate that they conform to the EMC and LVD directive of the European Union (EU).

CE marking



1. Product Model

Software: MX269020A LTE Downlink Measurement Software

2. Applied Directive and Standards

When the MX269020A LTE Downlink Measurement Software is installed in the MS2690A/MS2691A/MS2692A or MS2830A, the applied directive and standards of this unit conform to those of the MS2690A/MS2691A/MS2692A or MS2830A main frame.

PS: About main frame

Please contact Anritsu for the latest information on the main frame types that the MX269020A can be used with.

RCM Conformity Marking

Anritsu affixes the RCM mark on the following product(s) in accordance with the regulation to indicate that they conform to the EMC framework of Australia/New Zealand.

RCM marking



1. Product Model

Software: MX269020A LTE Downlink Measurement Software

2. Applied Directive and Standards

When the MX269020A LTE Downlink Measurement Software is installed in the MS2690A/MS2691A/MS2692A or MS2830A, the applied directive and standards of this unit conform to those of the MS2690A/MS2691A/MS2692A or MS2830A main frame.

PS: About main frame

Please contact Anritsu for the latest information on the main frame types that the MX269020A can be used with.

About This Manual

■ Composition of Operation Manuals

The operation manuals for the MX269020A LTE Downlink Measurement Software are comprised as shown in the figure below.

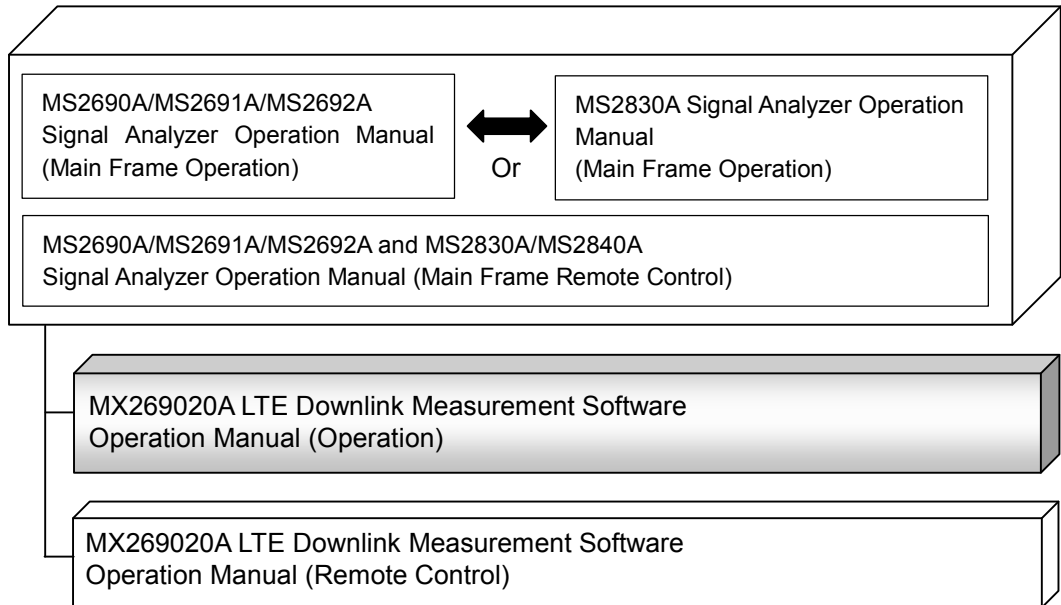

- Signal Analyzer Operation Manual (Mainframe Operation)
- Signal Analyzer Operation Manual (Mainframe Remote Control)

These manuals describe basic operating methods, maintenance procedures, common functions, and common remote control of the signal analyzer mainframe.

- LTE Downlink Measurement Software Operation Manual (Operation) <This document>

This manual describes basic operating methods, and functions of the LTE Downlink Measurement Software.

As for signal analyzer hardware and its basic functions and operation outline, refer to *MS2690A/MS2691A/MS2692A Signal Analyzer Operation Manual (Mainframe Operation)* or *MS2830A Signal Analyzer Operation Manual (Mainframe Operation)*.

- LTE Downlink Measurement Software Operation Manual (Remote Control)

This manual describes remote control of the LTE Downlink Measurement Software.

As for signal analyzer application's basic remote control functions and its definitions of common commands, refer to *MS2690A/MS2691A/MS2692A and MS2830A/MS2840A Signal Analyzer Operation Manual (Mainframe Remote Control)*.

Convention Used in This Manual

Throughout this document, the use of MS269x Series is assumed unless otherwise specified. If using MS2830A, change MS269xA to read MS2830A.

In this document,  indicates a panel key.

Table of Contents

| | |
|--|------------|
| About This Manual..... | I |
| Chapter 1 Overview..... | 1-1 |
| 1.1 Product Overview..... | 1-2 |
| 1.2 Product Configuration | 1-3 |
| 1.3 Specifications | 1-4 |
| Chapter 2 Preparation..... | 2-1 |
| 2.1 Part Names | 2-2 |
| 2.2 Signal Path Setup | 2-11 |
| 2.3 Application Startup and Selection | 2-12 |
| 2.4 Initialization and Calibration | 2-13 |
| Chapter 3 Measurement | 3-1 |
| 3.1 Basic Operation | 3-3 |
| 3.2 Frequency Function Menu | 3-6 |
| 3.3 Amplitude Function Menu | 3-7 |
| 3.4 Capture IQ Data Function Menu | 3-9 |
| 3.5 Common Setting Function Menu | 3-12 |
| 3.6 Measure Function Menu | 3-17 |
| 3.7 Setting Marker..... | 3-70 |
| 3.8 Setting Trigger | 3-74 |
| 3.9 EVM Display (Modulation Analysis)..... | 3-77 |
| 3.10 Constellation Display (Modulation Analysis)..... | 3-79 |
| 3.11 EVM vs Subcarrier Display (Modulation Analysis) | 3-83 |
| 3.12 EVM vs Symbol Display (Modulation Analysis)..... | 3-85 |
| 3.13 Spectral Flatness Display (Modulation Analysis)..... | 3-87 |
| 3.14 Power vs Resource Block Display (Modulation Analysis) | 3-89 |
| 3.15 EVM vs Resource Block Display (Modulation Analysis) | 3-91 |
| 3.16 Summary Display (Modulation Analysis) | 3-93 |
| 3.17 Test Model Summary Display (Modulation Analysis) ... | 3-96 |
| 3.18 Displaying RE Map (Modulation Analysis)..... | 3-97 |
| 3.19 MIMO Summary Display | 3-99 |
| 3.20 Batch Measurement Display | 3-101 |
| 3.21 Saving Measurement Results | 3-104 |

| |
|----------|
| 1 |
| 2 |
| 3 |
| 4 |
| 5 |
| 6 |
| Appendix |
| Index |

| | |
|--|----------------|
| Chapter 4 Digitize Function..... | 4-1 |
| 4.1 Saving IQ Data..... | 4-2 |
| 4.2 Replay Function | 4-7 |
| | |
| Chapter 5 Performance Test | 5-1 |
| 5.1 Overview of Performance Test | 5-2 |
| 5.2 Performance Test Items..... | 5-3 |
| | |
| Chapter 6 Other Functions | 6-1 |
| 6.1 Selecting Other Functions..... | 6-2 |
| 6.2 Setting Title | 6-2 |
| 6.3 Erasing Warmup Message | 6-2 |
| | |
| Appendix A Error Messages..... | A-1 |
| | |
| Appendix B Default Value List | B-1 |
| | |
| Appendix C LTE Downlink | |
| Signal Configuration | C-1 |
| | |
| Index | Index-1 |

Chapter 1 Overview

This chapter provides an overview of the MX269020A LTE Downlink Measurement Software and describes the product configuration.

| | | |
|-----|------------------------------------|-----|
| 1.1 | Product Overview | 1-2 |
| 1.2 | Product Configuration | 1-3 |
| | 1.2.1 Standard configuration | 1-3 |
| | 1.2.2 Option | 1-3 |
| | 1.2.3 Applicable parts | 1-3 |
| 1.3 | Specifications | 1-4 |

1.1 Product Overview

The MS269x Series and MS2830A Signal Analyzer enables high-speed, high-accuracy, and simple measurements of transmission characteristics of base stations and mobile stations for various mobile communications types. The MS2690A/MS2691A/MS2692A or MS2830A is equipped with high-performance signal analyzer and spectrum analyzer functions as standard, with optional measurement software allowing modulation analysis functionality supporting various digital modulation modes.

The MX269020A LTE Downlink Measurement Software (hereinafter, referred to as “MX269020A”) is a software option for measuring RF characteristics of LTE (FDD) downlink specified by 3GPP.

The MX269020A provides the following measurement features.

- Modulation accuracy measurement
- Carrier frequency measurement
- Transmitter power measurement

MS2830A-005/105 and MS2830A-006/106 is required to use the MX269020A on MS2830A.

1.2 Product Configuration

1.2.1 Standard configuration

Table 1.2.1-1 lists the standard configuration of the MX269020A.

Table 1.2.1-1 Standard configuration

| Item | Model Name/Symbol | Product Name | Q'ty | Remarks |
|-------------|-------------------|-----------------------------------|------|---|
| Application | MX269020A | LTE Downlink Measurement Software | 1 | |
| Accessory | — | Installation CD-ROM | 1 | Application software, operation manual CD-ROM |

1.2.2 Option

Tables 1.2.2-1 list the option for the MX269020A. This is sold separately.

Table 1.2.2-1 Option

| Option No. | Product Name | Remarks |
|---------------|--|---------|
| MX269020A-001 | LTE-Advanced FDD Downlink Measurement Software | |

1.2.3 Applicable parts

Table 1.2.3-1 lists the applicable parts for the MX269020A.

Table 1.2.3-1 Applicable parts

| Model Name/Symbol | Product Name | Remarks |
|-------------------|---|--------------------------|
| W3014AE | MX269020A LTE Downlink Measurement Software Operation Manual (Operation) | English, printed version |
| W3064AE | MX269020A LTE Downlink Measurement Software Operation Manual (Remote Control) | English, printed version |

1.3 Specifications

Table 1.3-1 shows the specifications for the MX269020A.

When MS2830A is used, this software's specification is specified by the condition below, unless otherwise noted.

Attenuator Mode: Mechanical Atten Only

Table 1.3-1 Specifications

| Item | Specification |
|----------------------------------|---|
| Common Specifications | |
| Channel bandwidth | 1.4, 3, 5, 10, 15, 20 MHz |
| Target signal | Downlink |
| Capture time | Capture Time = Auto : 1 Frame Capture Time = Manual : 1 to 200 Frame |
| Modulation/Frequency Measurement | |
| Measurement frequency ranges | MS269x Series: 600 to 4000 MHz MS2830A: 600 to 4000 MHz MS2830A-040: 600 to 3600 MHz |
| Measurement level range | -15 to +30 dBm (at Pre-Amp Off, or Pre-Amp not installed.) -15 to +10 dBm (at Pre-Amp On) |
| Carrier frequency accuracy | After CAL execution at 18 to 28°C For a signal of EVM = 1% For Measurement Interval = 10Subframe MS269x Series ± (accuracy of reference frequency × carrier frequency + 3 Hz) (Excluding the Batch Measurement when the wideband option (x04) is installed) MS2830A ± (accuracy of reference frequency × carrier frequency + 3.5 Hz) (When the center frequency is from 600 MHz to 2700 MHz and the wideband option (x78) is not installed) ± (accuracy of reference frequency × carrier frequency + 8.0 Hz) (When the center frequency is from 2700 MHz to 4000 MHz and the wideband option (x78) is not installed) ± (accuracy of reference frequency × carrier frequency + 4.0 Hz) (In the CC of the center frequency when the center frequency is from 600 MHz to 2700 MHz and the wideband option (x78) is installed) (At the input level of -4dBm when MS2830A-045 is installed) ± (accuracy of reference frequency × carrier frequency + 8.0 Hz) (In the CC of the center frequency when the center frequency is from 2700 MHz to 4000 MHz and the wideband option (x78) is installed) (At the input level of -4dBm when MS2830A-045 is installed) |

Table 1.3-1 Specifications (Cont'd)

| Item | Specification |
|---|--|
| Residual EVM | <p>After CAL execution at 18 to 28°C At measurement Interval = 10 subframe</p> <p>MS269x Series : < 1.0% (rms) (When the wideband option (x78) or excluding the Batch Measurement when the wideband option (x04) is installed) < 1.3% (rms) (In the CC of the center frequency when the wideband option (x78) is installed)</p> <p>MS2830A : < 1.3% (rms) At the input level of -4dBm when MX2830A-045 is installed)</p> |
| Transmitter power accuracy | <p>After CAL execution, input attenuator ≥ 10 dB, at 18 to 28°C, the input signal is within the measurement level range and below the value set in Input Level.</p> <p>MS269x Series (Excluding the Batch Measurement when the wideband option (x04) is installed) ±0.6 dB (at Pre-Amp Off, or Pre-Amp not installed.) ±1.1 dB (at Pre-Amp On)</p> <p>MS2830A ±0.6 dB (at Pre-Amp Off, or Pre-Amp not installed.)</p> <p>Transmitter power accuracy is calculated from an RSS (root summed square) error of the absolute amplitude accuracy and the in-band frequency characteristics of the MS2690A/MS2691A/MS2692A or MS2830A.</p> |
| Waveform display | <p>Provides functions for displaying waveforms below.</p> <p>Constellation EVM vs Subcarrier EVM vs Symbol Power vs Resource Block EVM vs Resource Block Spectral Flatness</p> |
| Adjacent Channel Power Measurement | |
| Measurement method | Executes the adjacent channel power measurement function of the Spectrum Analyzer or Signal Analyzer. |
| Occupied Bandwidth Measurement | |
| Measurement method | Executes the occupied bandwidth measurement function of the Spectrum Analyzer or Signal Analyzer. |
| Channel Power Measurement | |
| Measurement method | Executes the channel power measurement function of the Spectrum Analyzer or Signal Analyzer. |
| Spectrum Emission Mask Measurement | |
| Measurement method | Executes the spectrum emission mask measurement function of the Spectrum Analyzer. |

Table 1.3-1 Specifications (Cont'd)

| Item | Specification |
|-------------------|--|
| Digitize Function | |
| | Capable of outputting captured waveform data to internal hard disk or external hard disk. |
| Waveform Data | Format: I,Q (32 bit floating point binary format) Level: Assumes as $\sqrt{I^2 + Q^2} = 1$ for 0 dBm input Level accuracy: Same as the absolute amplitude accuracy and in-band frequency characteristics of the signal analyzer. |
| Replay Function | |
| | Analyzes traces of saved waveform data Format :I, Q (32 bit floating point binary format) Sampling rate: 50 MHz |

Chapter 2 Preparation

This chapter describes the preparations required for using the application you are using. Refer to the *MS2690A/MS2691A/MS2692A Signal Analyzer Operation Manual (Mainframe Operation)* or *MS2830A Signal Analyzer Operation Manual (Mainframe Operation)* for common features not included in this manual.

| | | |
|-----|--|------|
| 2.1 | Part Names | 2-2 |
| | 2.1.1 Front panel | 2-2 |
| | 2.1.2 Rear panel | 2-8 |
| 2.2 | Signal Path Setup | 2-11 |
| 2.3 | Application Startup and Selection..... | 2-12 |
| | 2.3.1 Launching application..... | 2-12 |
| | 2.3.2 Selecting application..... | 2-12 |
| 2.4 | Initialization and Calibration..... | 2-13 |
| | 2.4.1 Initialization..... | 2-13 |
| | 2.4.2 Calibration | 2-13 |

2.1 Part Names

This section describes the panel keys for operating the instrument and connectors used to connect external devices. For general points of caution, refer to the *MS2690A/MS2691A/MS2692A Signal Analyzer Operation Manual (Mainframe Operation)* or *MS2830A Signal Analyzer Operation Manual (Mainframe Operation)*.

2.1.1 Front panel

This section describes the front-panel keys and connectors.

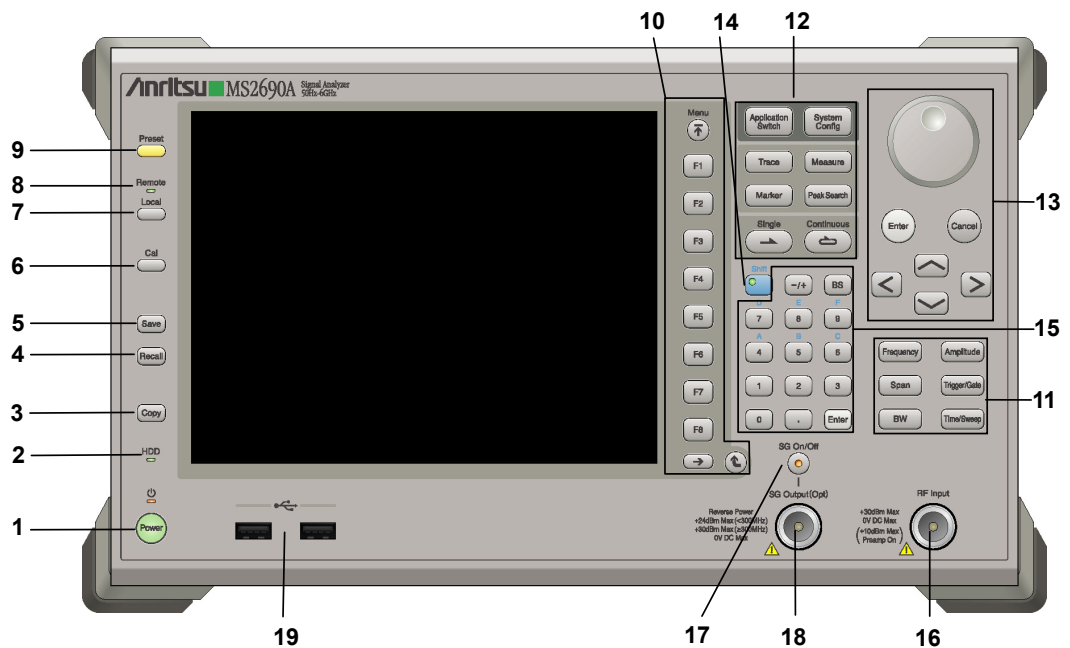

Figure 2.1.1-1 MS269x series front panel

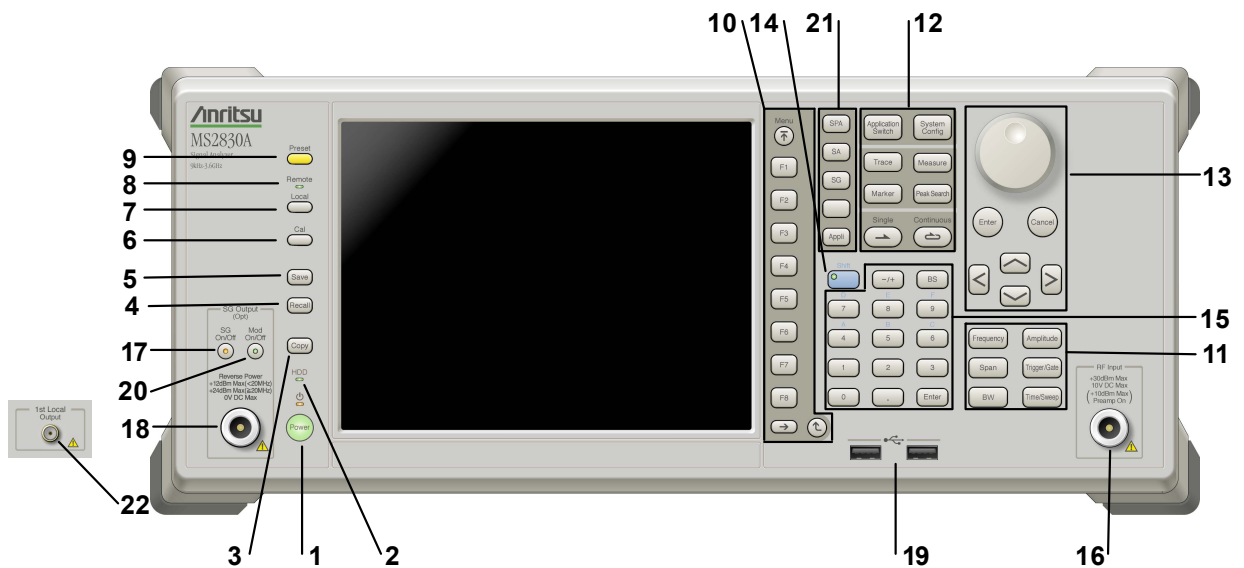
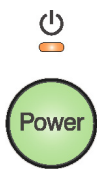







Figure 2.1.1-2 MS2830A front panel

-
- 1  **Power Switch**
Press to switch between the standby state (AC power supplied) and power-on state. The Power lamp  lights orange at Standby and green at Power On. Press the power switch for about 2 seconds.
 - 2  **Hard disk access lamp**
Lights when accessing the internal hard disk
 - 3  **Copy key**
Press to capture display screen and save to file.
 - 4  **Recall key**
Press to recall parameter file.
 - 5  **Save key**
Press to save parameter file.
 - 6  **Cal key**
Press to display the Calibration menu.



Local key

Press to return to local operation from remote control via GPIB, Ethernet, or USB (B), and enable panel settings.



Remote lamp

Lights when in remote-control state



Preset key

Resets parameters to initial settings



10



Function keys

Selects or configures function menu displayed on the right of the screen. The function menu is provided in multiple pages and layers.

Press  to fetch next function menu page. The current page number is displayed at the bottom of the function menu, as in “1 of 2”.

Sub-menus may be displayed when a function menu is pressed. Press  to go back to the previous menu. Press  to go back to the top menu.

11





Main function keys 1

Press to set or execute main functions.

Executable functions vary with the current application. When nothing happens with the press, it indicates that the application in use does not support the key.

 Press to set frequency parameters.

 Press to set level parameters.

 No function is assigned to this key.

 Press to set trigger parameters.

 No function is assigned to this key.

 Press to set measurement item parameters.

12





Main function keys 2

Press to set or execute main functions.

Executable functions vary with the current application. When nothing happens with the press, it indicates that the application in use does not support the key.

 Press to switch application.

 Press to display Configuration screen.

 Press to set the trace items or to switch the operation window.

 Press to set measurement item parameters.

 Use when switching graph marker operation.

 Press to set parameters related to the peak search function.

 Press to start single measurement.

 Press to start continuous measurements.

13

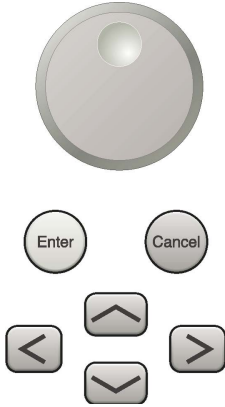

Rotary knob/Cursor key/Enter key/Cancel key

The rotary knob and cursor keys select display items or change settings.

Press  to set the entered or selected data.

Press  to cancel input or selected data.

14



Shift key

Operates keys with functions in blue characters on panel. Press the Shift key so the key lamp is green and then press the target key.

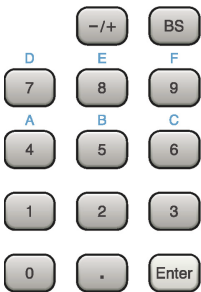

15



Numeric keypad

Enters numbers on parameter setup screens.

Press  to delete the last entered digit or character.

[A] to [F] can be entered by pressing keys  to  while the Shift key lamp  is green.

16

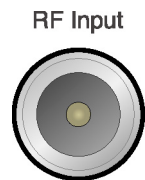

RF Input connector

Inputs RF signal. This is an N type input connector.

17



RF Output Control key

Press  to switch on/off the modulation of RF signal when the Vector Signal Generator option is installed. The RF output control key lamp lights orange when the RF signal output is set to On.

This is not available when the Option 044/045 is installed. (Only for MS2830A)

18 SG Output(Opt)



RF Output connector (when Option 020 installed)

Outputs RF signal, when the Vector Signal Generator option is installed. This is an N type output connector.

This is not available when the Option 044/045 is installed. (Only for MS2830A)

19

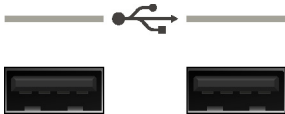

USB connector (type A)

Connect the accessory USB keyboard, mouse or USB memory.

20



Modulation control key (MS2830A only)

Press to switch on/off the modulation of RF signal when the Vector Signal Generator option is installed. The lamp  on the key lights up in green in the modulation On state.

This is not available when the Option 044/045 is installed.

21



Application key (MS2830A only)

Press to switch between applications.



Press to display the Spectrum Analyzer main screen.



Press to display the Signal Analyzer main screen, when Option 005/105 and 006/106 are installed.



Press to display the Signal Generator main screen, when Vector Signal Generator option is installed.



This is a blank key. Not used.



Displays the main screen of the application that is selected using the Application Switch (Auto), or displays that of the pre-selected application (Manual).

For details, refer to 3.5.4 “Changing application layout” in *MS2830A Signal Analyzer Operation Manual (Mainframe Operation)*.

22



1st Local Output connector (Only for MS2830A)

This is available when the Option 044/045 is installed.

Supplies local signal and bias current to the external mixer, and receives the IF signal with its frequency converted.

2.1.2 Rear panel

This section describes the rear-panel connectors.

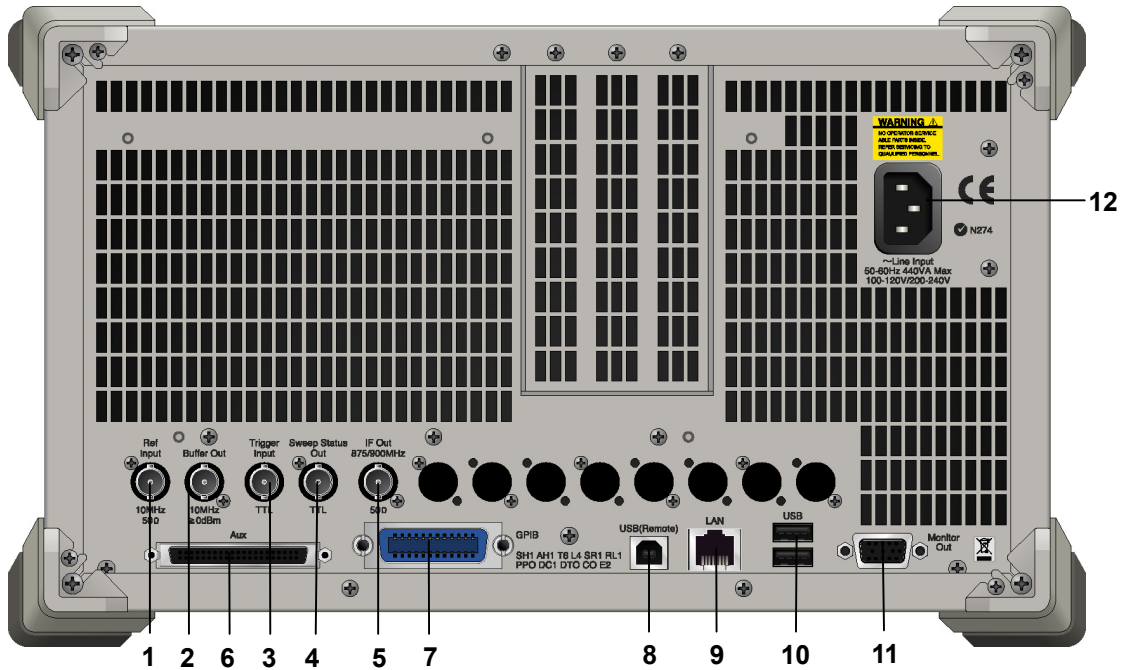

Figure 2.1.2-1 MS269x series rear panel

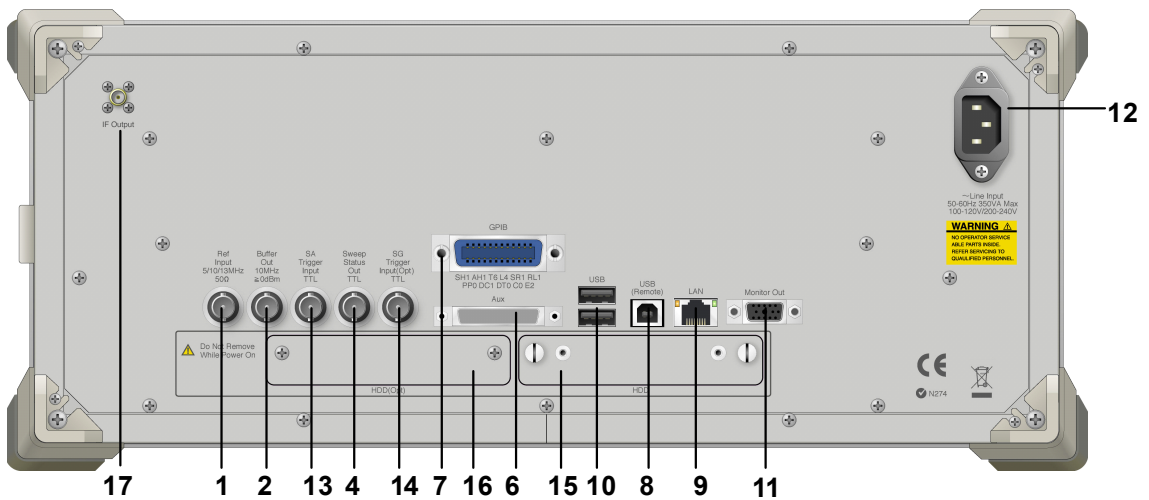





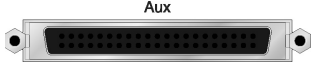
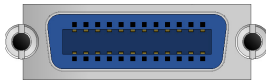











Figure 2.1.2-2 MS2830A rear panel

- | | | |
|---|--|---|
| 1 |  <p>Ref Input</p> | <p>Ref Input connector (reference frequency signal input connector)</p> <p>Inputs external reference frequency signal. It is for inputting reference frequency signals with higher accuracy than the instrument's internal reference signal, or for synchronizing the frequency of the MS2690A/MS2691A/MS2692A or MS2830A to that of other equipment. The following frequencies are supported:</p> <p>MS269x series: 10 MHz/13 MHz MS2830A: 5 MHz/10 MHz/13 MHz</p> |
| 2 |  <p>Buffer Out</p> | <p>Buffer Out connector (reference frequency signal output connector)</p> <p>Outputs the internal reference frequency signal (10 MHz). It is for synchronizing frequencies between other equipment and the MS2690A/MS2691A/MS2692A or MS2830A.</p> |
| 3 |  <p>Trigger Input</p> | <p>Trigger Input connector (MS269x series only)</p> <p>Inputs trigger signal from external device.</p> |
| 4 |  <p>Sweep Status Out</p> | <p>Sweep Status Out connector</p> <p>Outputs signal when internal measurement is performed or measurement data is obtained.</p> |
| 5 |  <p>IF Out 875/900MHz</p> | <p>IF Out connector (MS269x series only)</p> <p>Not used</p> |
| 6 |  <p>Aux</p> | <p>AUX connector</p> <p>Not used</p> |
| 7 |  <p>GP-IB</p> | <p>GP-IB connector</p> <p>For external control via GPIB.</p> |
| 8 |  <p>USB(Remote)</p> | <p>USB connector (type B)</p> <p>For external control via USB</p> |

Chapter 2 Preparation

- 9** **LAN**
 Ethernet connector
Connects PC or Ethernet network.
- 10** **USB**

 USB connector (type A)
Used to connect a USB keyboard or mouse or the USB memory supplied.
- 11** **Monitor Out**
 Monitor Out connector
Connects external display.
- 12**

~Line Input
50-60Hz 440VA Max
100-120V/200-240V
AC inlet
Supplies power.
- 13** **SA
Trigger
Input
TTL**
 SA Trigger Input connector (MS2830A only)
This is a BNC connector for inputting external trigger signal (TTL) for SPA and SA applications.
- 14** **SG
Trigger
Input(Opt)
TTL**
 SG Trigger Input connector (MS2830A only)
This is a BNC connector for inputting external trigger signal (TTL) for Vector Signal Generator option.
- 15** **HDD**
HDD slot (MS2830A only)
This is a standard hard disk slot.
- 16** **HDD(Opt)**
HDD slot for Option (MS2830A only)
This is a hard disk slot for the options.
- 17**  IF output connector (Only for MS2830A)
Monitor output of the internal IF signal.
This is available when the Option 044/045 is installed.

2.2 Signal Path Setup

As shown in Figure 2.2-1, connect the instrument and the DUT using an RF cable, so that the signal to be tested is input to the RF Input connector. To prevent an excessive level signal from being input, do not input the signal before setting the input level using this application.

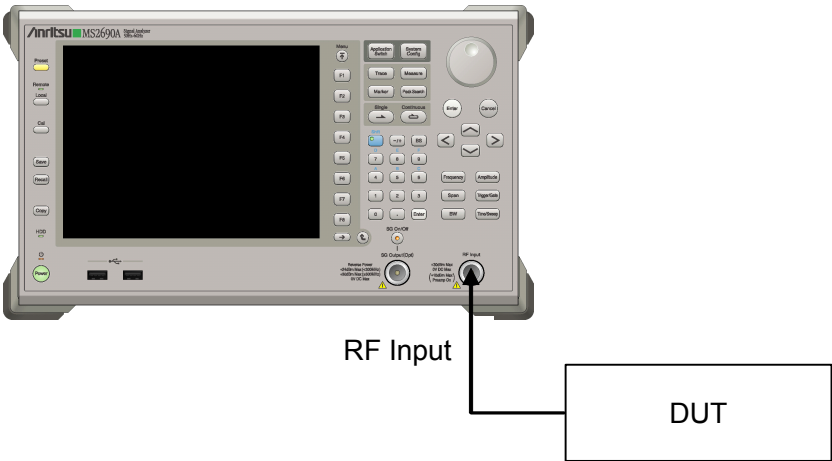

Figure 2.2-1 Signal path setup example

Set the reference signal and/or trigger signal paths from external sources, as required.

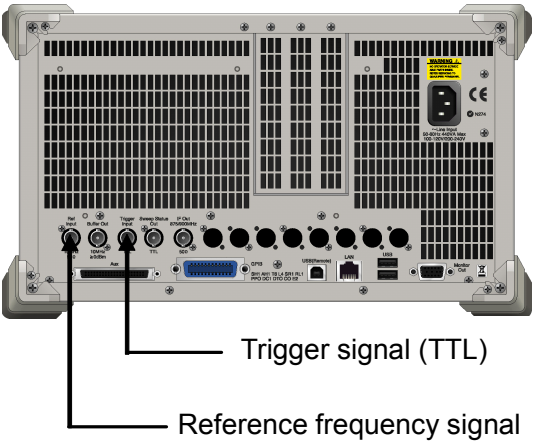

Figure 2.2-2 External signal input

2.3 Application Startup and Selection

To use this application, it is necessary to load (start up) and select the application.





2.3.1 Launching application

The application startup procedure is described below.

Note:

The XXX indicates the application name currently in use.

<Procedure>

1. Press  to display the Configuration screen.
2. Press  (Application Switch Settings) to display the Application Switch Registration screen.
3. Press  (Load Application Select), and move the cursor to “XXX” in the Unloaded Applications list.
If “XXX” is displayed in the **Loaded Applications** list, this means that the application is already loaded.
If “XXX” appears in neither the **Loaded Applications** nor **Unloaded Applications** list, this means that the application has not been installed.
4. Press  (Set) to load the application. If “XXX” is displayed in the **Loaded Applications list**, this means that the application is already loaded.

2.3.2 Selecting application

The selection procedure is described below.

<Procedure>

1. Press  to display the Application Switch menu.
2. Press the menu function key displaying “XXX”.

The application can also be selected with mouse, by clicking “XXX” on the task bar.

2.4 Initialization and Calibration

This section describes the parameter settings and the preparations required before starting measurement.

2.4.1 Initialization



After selecting this application, first perform initialization. Initialization returns the settable parameters to their default value in order to clear the measurement status and measurement results.

Note:

When another software application is switched to or this application is unloaded (ended), the application keeps the parameter settings at that time. The parameter values that were last set will be applied when this application is selected next time.

The initialization procedure is as follows.

<Procedure>

1. Press  to display the Preset function menu.
2. Press  (Preset).

2.4.2 Calibration

Perform calibration before performing measurement. Calibration sets the level accuracy frequency characteristics for the input level to flat, and adjusts level accuracy deviation caused by internal temperature fluctuations. Calibration should be performed when first performing measurement after turning on power, or if beginning measurement when there is a difference in ambient temperature from the last time calibration was performed.

<Procedure>

1. Press  to display the Application Cal function menu.
2. Press  (SIGANA All).

For details on calibration functionality only executable with this instrument, refer to the *MS2690A/MS2691A/MS2692A Signal Analyzer Operation Manual (Mainframe Operation)* or *MS2830A Signal Analyzer Operation Manual (Mainframe Operation)*.

Chapter 3 Measurement

This chapter describes the measurement function, the parameter contents and setting methods for the MX269020A.

| | | |
|--------|---|------|
| 3.1 | Basic Operation | 3-3 |
| 3.1.1 | Screen layout..... | 3-3 |
| 3.1.2 | Function menu..... | 3-4 |
| 3.1.3 | Performing measurement..... | 3-5 |
| 3.2 | Frequency Function Menu | 3-6 |
| 3.3 | Amplitude Function Menu | 3-7 |
| 3.4 | Capture IQ Data Function Menu..... | 3-9 |
| 3.4.1 | Setting capture time..... | 3-10 |
| 3.4.2 | Averaging IQ data..... | 3-11 |
| 3.5 | Common Setting Function Menu | 3-12 |
| 3.6 | Measure Function Menu | 3-17 |
| 3.6.1 | Modulation Analysis..... | 3-17 |
| 3.6.2 | MIMO Summary | 3-47 |
| 3.6.3 | Adjacent Channel Power Measurement (ACP)..... | 3-48 |
| 3.6.4 | Channel Power Measurement (Channel Power)..... | 3-48 |
| 3.6.5 | Occupied Bandwidth Measurement (OBW)..... | 3-49 |
| 3.6.6 | Spectrum Emission Mask Measurement (SEM) | 3-49 |
| 3.6.7 | Advanced Settings..... | 3-50 |
| 3.6.8 | Batch Measurement | 3-51 |
| 3.7 | Setting Marker..... | 3-70 |
| 3.8 | Setting Trigger | 3-74 |
| 3.9 | EVM Display (Modulation Analysis)..... | 3-77 |
| 3.10 | Constellation Display (Modulation Analysis)..... | 3-79 |
| 3.10.1 | Constellation (EVM vs Subcarrier, EVM vs Symbol, Spectral Flatness, RE Map) | 3-79 |
| 3.10.2 | Constellation (Power vs Resource Block, EVM vs Resource Block)..... | 3-81 |
| 3.11 | EVM vs Subcarrier Display (Modulation Analysis) | 3-83 |
| 3.12 | EVM vs Symbol Display (Modulation Analysis) | 3-85 |
| 3.13 | Spectral Flatness Display (Modulation Analysis)..... | 3-87 |
| 3.14 | Power vs Resource Block Display (Modulation Analysis) | 3-89 |
| 3.15 | EVM vs Resource Block Display (Modulation Analysis) | 3-91 |

| | | |
|------|--|-------|
| 3.16 | Summary Display (Modulation Analysis) | 3-93 |
| 3.17 | Test Model Summary Display (Modulation Analysis) . | 3-96 |
| 3.18 | Displaying RE Map (Modulation Analysis)..... | 3-97 |
| 3.19 | MIMO Summary Display..... | 3-99 |
| 3.20 | Batch Measurement Display..... | 3-101 |
| 3.21 | Saving Measurement Results..... | 3-104 |

3.1 Basic Operation

3.1.1 Screen layout

This section describes the screen layout for the MX269020A.



3

Measurement

Figure 3.1.1-1 Screen Layout

- [1] Measurement parameter
Displays the set parameters.
- [2] Status message
Displays the status of signals.
- [3] Constellation
Displays a constellation of the selected symbol.
- [4] Result window
Displays measurement results.
- [5] Function menu
Displays the functions executable with the function keys.
- [6] Graph window
Displays a graph of the measurement results.

3.1.2 Function menu

This section describes the main function menu on the main screen.

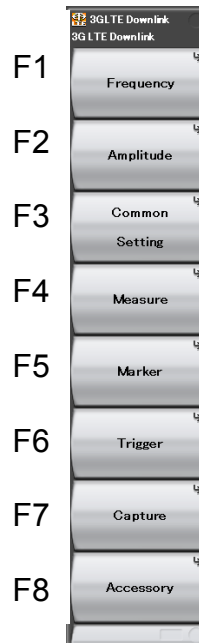









Figure 3.1.2-1 Main function menu

Table 3.1.2-1 Main function menu

| Menu Display | Function |
|----------------|---|
| Frequency | Sets the frequency  3.2 "Frequency Function Menu" |
| Amplitude | Sets level.  3.3 "Amplitude Function Menu" |
| Common Setting | Sets common items.  3.5 "Common Setting Function Menu" |
| Measure | Sets measurement items.  3.6 "Measure Function Menu" |
| Marker | Sets a marker.  3.7 "Setting Maker" |
| Trigger | Sets a trigger.  3.8 "Setting Trigger" |
| Capture | Configures settings for IQ data capture.  3.4 "Capture IQ Data Function Menu" |
| Accessory | Sets other functions.  6.1 "Selecting Other Functions" |

3.1.3 Performing measurement

There are two measurement modes: single and continuous. Measurement is performed once in the single measurement mode, and continuously in the continuous measurement mode, respectively.

Single

Following capture of an input signal based on the settings of Capture Time, the selected measurement items are measured only for the measurement count (Storage Count) before measurement is stopped.

<Procedure>

1. Press .

Continuous

Following capture of an input signal based on the settings of Capture Time, the selected measurement items are continuously measured for the measurement count (Storage Count). Measurement will continue even if parameters are changed or the window display is changed. Measurement will be stopped if another application is selected or if the Replay function is executed.

<Procedure>



1. Press .

Note :

The two measurement modes are not available when the Replay function is executed. If the Replay function is executed, analysis is started when an IQ data file is specified.

 4.2 "Replay Function"

3.2 Frequency Function Menu

Configure the frequency settings in the Frequency function menu that is displayed by pressing  (Frequency) on the main function menu. Also, press  to display the Frequency function menu and open the Carrier Frequency dialog box.

Note :

You cannot set any frequency when the Replay function is executed.

Carrier Frequency

■ Summary

Sets the carrier frequency.

■ Setting range

30 MHz to the upper limit of the main unit

(When MS269xA-004/104/078/178 or MS2830A-078 are not installed)

100 MHz to the upper limit of the main unit

(When MS269xA-004/104/078/178 are installed to the mainframe)

300 MHz to the upper limit of the main unit

(When MS2830A-078 is installed to the mainframe)

RF Spectrum

■ Summary

Sets whether to measure with IQ spectrum reversed.

■ Selection options

| | |
|-------|--|
| Norm. | Measures without IQ spectrum reversed. |
| Rvs. | Measures with IQ spectrum reversed. |

3.3 Amplitude Function Menu

Configure the level settings in the Amplitude function menu that is displayed by pressing **F2** (Amplitude) on the main function menu. Also, press **Amplitude** to display the Amplitude function menu and open the Input Level dialog box.

Note :

You cannot set a level when the Replay function is executed.

Input Level

■ Summary

Sets the input level from the target DUT.

■ Setting range

For Pre-Amp: On :

(-80.00 + Offset Value) to (10.00 + Offset Value) dBm

For Pre-Amp: Off:

(-60.00 + Offset Value) to (30.00 + Offset Value) dBm

Pre-Amp

■ Summary

Sets On/Off for the Pre-Amp function.

■ Selection options

On Enables the Pre-Amp function.

Off Disables the Pre-Amp function.

Offset

■ Summary

Sets On/Off for the Offset function.

■ Selection options

On Enables the offset function.

Off Disables the offset function.

Offset Value

■ Summary

Sets the level offset coefficient.

■ Setting range

-99.99 to 99.99 dB

■ Setting example

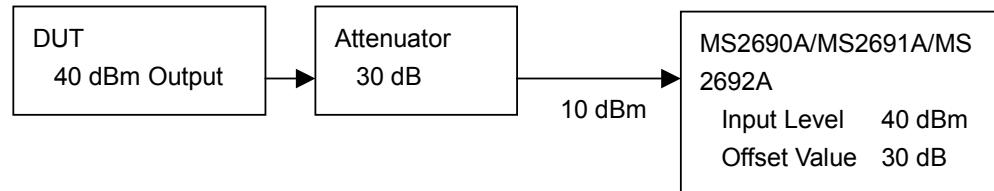

Auto Range

■ Summary

This function adjusts input level according to input signal.

You cannot set a frequency and level when the Replay function is executed.

 4.2 "Replay Function"

3.4 Capture IQ Data Function Menu

Configure the IQ data settings in the Capture function menu that is displayed by pressing **F7** (Capture) on the main function menu.

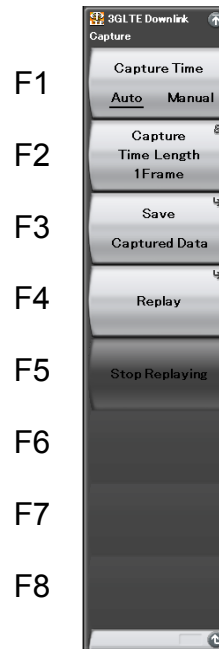





Figure 3.4-1 Capture function menu

Table 3.4-1 Capture function menu

| Menu Display | Function |
|----------------------------|--|
| Capture Time (Auto/Manual) | Switches between the two capture modes of IQ data (auto setting and manual setting). |
| Capture Time Length | Sets the capture time length of IQ data. |
| Save Captured Data | Saves the captured IQ data.  Chapter 4 “Digitize Function” |
| Replay | Replays the captured IQ data.  Chapter 4 “Digitize Function” |
| Stop Replaying | Stops replaying the captured IQ data.  Chapter 4 “Digitize Function” |

3.4.1 Setting capture time

Set the Capture Time (capture mode) and the Capture Time Length.

- Auto

The data required to measure one frame per measurement is automatically captured if Auto is selected (Auto mode is specified). The Auto mode is set by default for the MX269020A.

- Manual

The number of frames per measurement can be specified if Manual is selected to specify the Manual mode. The number of frames to be measured can be specified by using Capture Time Length. The setting range for Capture Time Length is from 1 to 200 frames. The frames in the area specified by Capture Time Length are continuous. The Manual mode is selected automatically if Capture Time Length is specified.

When performing adjacent channel power (ACP) measurement, channel power measurement, or occupied bandwidth (OBW) measurement by using the Replay function, save IQ data in the Manual mode.

3.4.2 Averaging IQ data

The averaging method depends on the capture time mode.

- Auto

In the Auto mode, capture of one frame starts at the trigger timing. After the measurement is completed, capture of another frame starts at the next trigger timing. The average and maximum values are calculated from the measurement results at each storage count. The frames of multiple measurements are not necessarily consecutive. The storage count and the capture count are the same in single measurement. In continuous measurement, the average and maximum values are calculated from the last data of the storage count after measurement has been performed the number of times corresponding to the storage count.

- Manual

In the Manual mode, if measurement starts at the trigger timing, frames are continuously captured for the number specified by Capture Time Length. After each frame measurement, the average and maximum values are calculated from the measurement results at each storage count.

In single measurement, the storage count is reached at each capture.

In continuous measurement, the single measurement operation is performed repeatedly.

In the manual mode, the storage count never exceeds the capture time length. Therefore, the maximum storage count equals the capture time length. If the capture time length is changed, the storage count is accordingly changed within the setting range.

3.5 Common Setting Function Menu

Set the common items in the Common Setting function menu that is displayed by pressing  (Common Setting) on the main function menu.

Channel Bandwidth

■ Summary

Selects the band of the input signal.

■ Selection options

| | |
|---------|---|
| 1.4 MHz | Analyzes an input signal as a 1.4-MHz band. |
| 3 MHz | Analyzes an input signal as a 3-MHz band. |
| 5 MHz | Analyzes an input signal as a 5-MHz band. |
| 10 MHz | Analyzes an input signal as a 10-MHz band. |
| 15 MHz | Analyzes an input signal as a 15-MHz band. |
| 20 MHz | Analyzes an input signal as a 20-MHz band. |

Test Model

■ Summary

Selects the type of the test model defined in 3GPP TS36.141.

■ Selection options

| | |
|----------|--|
| Off | Select when measuring signals other than the test model. |
| E-TM1.1 | Select when measuring E-TM1.1 signals. |
| E-TM1.2 | Select when measuring E-TM1.2 signals. |
| E-TM2 | Select when measuring E-TM2 signals. |
| E-TM2a | Select when measuring E-TM2a signals. |
| E-TM3.1 | Select when measuring E-TM3.1 signals. |
| E-TM3.1a | Select when measuring E-TM3.1a signals. |
| E-TM3.2 | Select when measuring E-TM3.2 signals. |
| E-TM3.3 | Select when measuring E-TM3.3 signals. |

Synchronization Mode

■ Summary

Sets the synchronized signal.

■ Selection options

Synchronization signal

Sets Synchronization Signal for the synchronized signal.

Reference Signal Sets Reference Signal for the synchronized signal.

Note:

If Synchronization Signal is selected, the input signal includes Primary Synchronization Signal (P-SS) and Secondary Synchronization Signal (S-SS).

Table 3.5-1 shows the synchronization methods for signals of the MX269020A.

Table 3.5-1 Synchronization method

| Synchronization Mode | Reference Signal Mode | Synchronization Method |
|-----------------------------|-----------------------|--|
| Synchronization Signal (SS) | Auto | Searches for a synchronization signal from the received signal, and estimates the cell ID based on the searched signal. Generates a reference signal based on the estimated cell ID, and estimates the channel. |
| | Using Cell ID | Searches for a synchronization signal from the received signal. Generates a reference signal based on the set cell ID, and estimates the channel. |
| | Load File | Searches for a synchronization signal from the received signal. Estimates the channel based on the reference signal defined in the external file. |
| Reference Signal (RS) | Using Cell ID | Generates a reference signal based on the set cell ID, and synchronizes frames and estimates the channel. |
| | Load File | Synchronizes frames and estimates the channel based on the reference signal defined in the external file. |

Reference Signal

■ Summary

Sets Reference Signal.

■ Selection options

Reference Signal Mode

Sets the Reference Signal mode.

Reference Signal Load

Specifies a file in which a reference signal is defined.

Frequency Shift

Sets the frequency shift of the Reference Signal.

Cell ID

Sets the Cell ID of the Reference Signal.

Power Boosting

Sets the boost level of the reference signal.

Number of Antenna Ports

Sets the number of antennas to be used for transmission.

Antenna Port

Sets the antenna port number to be measured.

Reference Signal: Reference Signal Mode

■ Summary

Sets the Reference Signal mode.

■ Selection options

Auto

Determines the Reference Signal through automatic judgment.

Using Cell ID

Determines the Reference Signal according to the Cell ID setting.

Load File

Determines the Reference Signal according to an external file.

Note:

Auto can be selected only when Synchronization Mode is set to Synchronization Signal.

Reference Signal: Reference Signal Load

■ Summary

Sets Reference Signal Load. This setting is enabled if Reference Signal Mode is set to Load File. If no file is specified, the default definition for the software applies.

■ Selection options

| | |
|--------------|---|
| Device | Specifies the drive in which the reference signal is defined. |
| Load File | Selects the file in which the reference signal is defined. It is selectable from a csv file in a root directory of the drive specified by Device. |
| Default Load | Returns the reference signal to default. |

Reference Signal: Frequency Shift

■ Summary

Sets the frequency shift of the Reference Signal. This setting is enabled when Load File is set for Reference Signal Mode.

■ Setting range

0 to 5

Reference Signal: Cell ID

■ Summary

Sets the Cell ID of the Reference Signal. This setting is enabled when CC Settings: Reference Signal Mode is set to Using Cell ID.

■ Setting range

0 to 503

Reference Signal: Power Boosting

■ Summary

Sets the boost level of the Reference Signal.

■ Setting range

-20.000 to +20.000 dB

Reference Signal: Number of Antenna Ports

■ Summary

Sets the number of antennas.

■ Selection options

- | | |
|---|--|
| 1 | Analyzes under the condition that the number of antennas used for transmission is 1. |
| 2 | Analyzes under the condition that the number of antennas used for transmission is 2. |
| 4 | Analyzes under the condition that the number of antennas used for transmission is 4. |

Reference Signal: Antenna Port



■ Summary

Sets the antenna port number to be measured.

■ Setting range

0 to Number of Antenna Ports – 1

3.6 Measure Function Menu

To set the measurement items, press  (Measure) on the main function menu or  to display the Measure function menu.

3.6.1 Modulation Analysis

To set modulation analysis items, press  (Modulation Analysis) on the Measure function menu to display the Modulation Analysis function menu.





The Modulation Analysis function menu consists of two pages that are toggled by pressing .

Table 3.6.1-1 Modulation Analysis function menu

| Position | Menu Display | Function |
|-------------|-------------------------------------|---|
| Page 1 [F1] | Analysis Time | Sets measurement position.  3.6.1.1 "Analysis Time" |
| Page 1 [F2] | PDSCH Modulation Scheme | Sets PDSCH Modulation Scheme. |
| Page 1 [F3] | Channel Bandwidth | Sets Channel Bandwidth.  3.5 "Common Setting Function Menu" |
| Page 1 [F5] | Total EVM & Constellation Composite | Sets the channel to be targeted for the total EVM calculation and displayed in a constellation. |
| Page 1 [F6] | EVM Window Length | Sets FFT window length. |
| Page 1 [F7] | Detail Settings | Sets details of measured signal. |
| Page 1 [F8] | Optional Measurements | Sets whether to analyze IQ skew, IQ imbalance, and IQ quadrature error. |
| Page 2 [F1] | Trace | Sets Trace.  3.6.1.2 "Trace" |
| Page 2 [F8] | PDCCH Mapping Load | Loads the PDCCH configuration file. |

PDSCH Modulation Scheme

■ Summary

Sets PDSCH Modulation Scheme.

Select AUTO if the measurement target includes multiple modulation schemes.

■ Selection options

QPSK Analyzes an input signal as a QPSK modulated signal.

16QAM Analyzes an input signal as a 16QAM modulated signal.

64QAM Analyzes an input signal as a 64QAM modulated signal.

256QAM Analyzes an input signal as a 256QAM modulated signal.

AUTO Analyzes an input signal after judging its modulation scheme automatically (Excluding 256QAM).

Total EVM & Constellation Composite

■ **Summary**

Sets the channel to be targeted for the total EVM calculation and displayed in a constellation. The possible channels are RS, PDSCH, PBCH, P-SS, S-SS, PDCCH, PCFICH, PHICH, and DTX.

■ **Selection options**

Include Includes the channel in the calculation.

Exclude Excludes the channel from the calculation.

EVM Window Length

■ **Summary**

Sets FFT window length. There are two setting methods: Ts and W. If the channel bandwidth is changed, the setting is restored to the default value according to the changed channel bandwidth. (See Table 3.6.1-2.)

■ **Setting range**

Ts 0 to 142

W When Channel Bandwidth is set to 1.4 MHz: 0 to 8

When Channel Bandwidth is set to 3 MHz: 0 to 17

When Channel Bandwidth is set to 5 MHz: 0 to 35

When Channel Bandwidth is set to 10 MHz: 0 to 71

When Channel Bandwidth is set to 15 MHz: 0 to 106

When Channel Bandwidth is set to 20 MHz: 0 to 142

Table 3.6.1-2 Default value of Channel Bandwidth and EVM Window Length

| Channel Bandwidth | EVM Window Length (W) | Conversion from W to Ts |
|-------------------|-----------------------|-------------------------|
| 1.4 MHz | 5 | × 16 |
| 3 MHz | 12 | × 8 |
| 5 MHz | 32 | × 4 |
| 10 MHz | 66 | × 2 |
| 15 MHz | 102 | × (2048 / 1536) |
| 20 MHz | 136 | ×1 |

Detail Setting: Test Model

■ Summary

Sets the type of test models. The value is the same as that displayed in the Common Setting function menu.

 3.5 “Common Setting Function Menu”

Detail Setting: Synchronization Mode

■ Summary

Sets the synchronized signal. The value is the same as that displayed in the Common Setting function menu.

 3.5 “Common Setting Function Menu”

Detail Setting: Reference Signal Mode

■ Summary

Sets the mode of Reference Signal.

The value is the same as that displayed in the Common Setting function menu.

 3.5 “Common Setting Function Menu”

Detail Setting: Frequency Shift

■ Summary

Sets the amount of frequency shifts for the reference signal.

The value is the same as that displayed in the Common Setting function menu.

 3.5 “Common Setting Function Menu”

Detail Setting: Cell ID

■ Summary

Sets the cell ID for the reference signal.

The value is the same as that displayed in the Common Setting function menu.

 3.5 “Common Setting Function Menu”

Detail Setting: Reference Signal Power Boosting

■ Summary

Sets the boosting level for the reference signal.

The value is the same as that displayed in the Common Setting function menu.

 3.5 “Common Setting Function Menu”

Detail Setting : Number of Antenna Ports

■ Summary

Sets the number of antennas. The value is the same as that displayed in the Common Setting function menu.

 3.5 “Common Setting Function Menu”

Detail Setting : Antenna Port

■ Summary

Sets the antenna port number to be measured.
The value is the same as that displayed in the Common Setting function menu.

 3.5 “Common Setting Function Menu”

Details PBCH On/Off

■ Summary

Selects whether to include PBCH for the target measurement.
Available when Test Model is set to Off.

■ Selection options

| | |
|-------------|---|
| Checked | Target measurement includes PBCH. |
| Non-Checked | Target measurement does not include PBCH. |

Detail Setting: PBCH Power Boosting (Auto/Manual)

■ Summary

Selects whether to detect PBCH power automatically or manually.
Available when Test Model is set to Off and PBCH is set to On.

■ Selection options

| | |
|--------|---------------------|
| Auto | Automatic detection |
| Manual | Manual detection |

Detail Setting: PBCH Power Boosting

■ Summary

Sets a value relative to the reference signal level to the PBCH level.
This setting is enabled when PBCH is set to On and when PBCH Power Boosting is set to Manual.

■ Setting range

-20.000 to +20.000 dB

Detail Setting: P-SS On/Off**■ Summary**

Selects whether the measurement target includes the primary synchronization signal. The check box is always selected if Synchronization Signal is selected for Synchronization Mode. Available when Test Model is set to Off.

■ Selection options

Checked The measurement target includes P-SS.
Non-Checked The measurement target does not include P-SS.

Detail Setting: P-SS Power Boosting (Auto/Manual)**■ Summary**

Selects whether to detect the primary synchronization signal power automatically or manually. Available when Test Model is set to Off and P-SS is set to On.

■ Selection options

Auto Automatic detection
Manual Manual detection

Detail Setting: P-SS Power Boosting**■ Summary**

Sets a value relative to the reference signal level to the primary synchronization signal level. This setting is enabled when P-SS is set to On and when P-SS Power Boosting is set to Manual.

■ Setting range

-20.000 to +20.000 dB

Detail Setting: S-SS On/Off**■ Summary**

Select whether the measurement target includes the primary synchronization signal. The check box is always selected if Synchronization Signal is selected for Synchronization Mode. Available when Test Model is set to Off.

■ Selection options

Checked The measurement target includes S-SS.
Non-Checked The measurement target does not include S-SS.

Detail Setting: S-SS Power Boosting (Auto/Manual)

■ Summary

Selects whether to detect the secondary synchronization signal power automatically or manually.

Available when Test Model is set to Off and S-SS is set to On.

■ Selection options

| | |
|--------|---------------------|
| Auto | Automatic detection |
| Manual | Manual detection |

Detail Setting: S-SS Power Boosting

■ Summary

Sets a value relative to the reference signal level to the secondary synchronization signal level. This setting is enabled when S-SS is set to On and when S-SS Power Boosting is set to Manual.

■ Setting range

-20.000 to +20.000 dB

Detail Setting: PDCCH On/Off

■ Summary

Select whether the measurement target includes PDCCH.

Available when Test Model is set to Off.

■ Selection options

| | |
|-------------|--|
| Checked | The measurement target includes PDCCH. |
| Non-Checked | The measurement target does not include PDCCH. |

Detail Setting: PDCCH Power Boosting (Auto/Manual)

■ Summary

Selects whether to detect the PDCCH power automatically or manually.

Available when Test Model is set to Off, PDCCH is set to On, and Number of PDCCHs is more than 1.

■ Selection options

| | |
|--------|---------------------|
| Auto | Automatic detection |
| Manual | Manual detection |

Detail Setting: PDCCH Power Boosting**■ Summary**

Sets a value relative to the reference signal level to the PDCCH level. This setting is enabled if PDCCH is On, Number of PDCCH is set to 1 or greater, and PDCCH Power Boosting is set to Manual.

■ Setting range

-20.000 to +20.000 dB

Detail Setting: PCFICH On/Off**■ Summary**

Select whether the measurement target includes PCFICH.
Available when Test Model is set to Off.

■ Selection options

Checked The measurement target includes PCFICH.
Non-Checked The measurement target does not include PCFICH.

Detail Setting: PCFICH Power Boosting (Auto/Manual)**■ Summary**

Selects whether to detect the PCFICH power automatically or manually.
Available when Test Model is set to Off and PCFICH is set to On.

■ Selection options

Auto Automatic detection
Manual Manual detection

Detail Setting: PCFICH Power Boosting**■ Summary**

Sets a value relative to the reference signal level to the PCFICH level. .
This setting is enabled when PCFICH is set to On and when PCFICH Power Boosting is set to Manual.

■ Setting range

-20.000 to +20.000 dB

Detail Setting: PHICH On/Off**■ Summary**

Select whether the measurement target includes PHICH.
Available when Test Model is set to Off.

■ Selection options

Checked The measurement target includes PCHICH.
Non-Checked The measurement target does not include PCHICH.

Detail Setting: PHICH Power Boosting (Auto/Manual)

■ Summary

Selects whether to detect the power of the PHICH group automatically or manually.

Available when Test Model is set to Off and PHICH is set to On.

■ Selection options

| | |
|--------|-------------------|
| Auto | Automatic setting |
| Manual | Manual setting |

Detail Setting: PHICH Power Boosting

■ Summary

Sets a value relative to the reference signal level to the level of the PHICH group.

This setting is enabled when PHICH is set to On and when PHICH Power Boosting is set to Manual.

■ Setting range

-20.000 to +20.000 dB

Detail Setting: PDSCH Power Boosting (Auto/Manual)

■ Summary

This selects automatic detection and manual setting of the PDCCH power. Available when Test Model is set to Off.

■ Selection options

| | |
|--------|------------------------|
| Auto | Detects automatically. |
| Manual | Sets manually. |

Detail Setting: PDSCH Power Boosting

■ Summary

Sets value relative to reference signal level at PDSCH level. This is enabled only when the PDSCH Power Boosting is set to Manual.

■ Setting range

-20.000 to +20.000 dB

Detail Setting: PHICH Ng

■ Summary

Sets a parameter (Ng) to determine the number of PHICH groups.

■ Selection options

| | |
|-----|--------------------|
| 1/6 | 1/6 is set for Ng. |
| 1/2 | 1/2 is set for Ng. |
| 1 | 1 is set for Ng. |
| 2 | 2 is set for Ng. |

Detail Setting: PHICH Duration

■ Summary

Sets the PHICH duration.

■ Selection options

| | |
|----------|----------|
| Normal | Normal |
| Extended | Extended |

Detail Setting: Number of PDCCH Symbols (Auto/Manual)

■ Summary

Selects whether to detect the number of PDCCH symbols automatically or manually. The automatic detection is performed by decoding PCFICH. This setting is enabled when PCFICH is set to On.

■ Selection options

| | |
|--------|---------------------|
| Auto | Automatic detection |
| Manual | Manual detection |

Details Setting: Number of PDCCH Symbols

■ Summary

Sets the number of symbol for PDCCH.

■ Setting range

When Channel Bandwidth is set to 1.4 MHz: 0 to 4

When Channel Bandwidth is set to other than 1.4 MHz: 0 to 3

Detail Setting: PDCCH Mapping

■ Summary

Sets mapping of PDCCH and NIL (dummy PDCCH) to the control channel elements (CCEs).

■ Setting range

| | |
|-----------|---|
| Auto | Automatically evaluates and measures PDCCH and NIL |
| Full | Performs measurement assuming that only PDCCHs are mapped (no NIL). Even if REG is a value smaller than the CCE unit, measurement is performed assuming that PDCCHs are mapped. |
| Easy | Performs measurement for all subframes according to the PDCCH mapping that is determined by the PDCCH Format and Number of PDCCHs parameters. Measurement is performed assuming that PDCCHs are mapped sequentially from the first CCE for the number specified by Number of PDCCHs in the unit specified by PDCCH Format. |
| Load File | Performs measurement according to the setting in the loaded file that is specified by PDCCH Mapping Load. |

Detail Setting: PDCCH Mapping - PDCCH Format

■ Summary

Sets the type of PDCCH format. This setting applies if PDCCH Mapping is set to Easy.

■ Setting range

0 to 3

Detail Setting: PDCCH Mapping - Number of PDCCHs**■ Summary**

Sets the number of PDCCHs to be mapped. This setting applies if PDCCH Mapping is set to Easy.

PDCCHs are mapped sequentially from CCE(0) for the number specified by this parameter, in the unit specified by PDCCH Format. If a value greater than the number of PDCCHs that can be mapped is specified, measurement is performed assuming that PDCCHs are mapped to all CCEs to which PDCCHs can be mapped.

■ Setting range

1 to 88

Detail Setting: Pseudo-Random Sequence**■ Summary**

Selects the version of 3GPP TS36.211 to which the specifications of the pseudo-random sequence should conform.

■ Selection options

| | |
|------------------------------|--|
| TS36. 211 V8. 2. 0 (2008-03) | Definitions in 3GPP TS36. 211 V8.2.0 |
| TS36. 211 V8. 3. 0 (2008-05) | Definitions in 3GPP TS36. 211 V8.3.0 to V8.7.0 and later |

Detail Setting: Channel Estimation**■ Summary**

Sets the Channel Estimation function to On/Off.

■ Selection options

| | |
|-------------|---|
| Checked | Enables the Channel Estimation function. |
| Non-Checked | Disables the Channel Estimation function. |

Detail Setting: Moving Average Filter**■ Summary**

Sets the window size for the 10th and subsequent subcarriers defined in 3GPP TS36. 141 F3. 4 Post FFT equalization. This is available when Channel Estimation is set to On.

■ Setting range

1 to 71

Detail Setting : Measurement Filter Type

■ Summary

Selects filter type used for modulation analysis.

Notes:

- This function is not available for Mean Power and Output Power measurements.
- This is available when Extended Freq Lock Range is set to Off.

■ Selection options

| | |
|--------|--|
| Normal | Use this when measuring single carrier signal. |
| Narrow | Use this when measuring multi-carrier signal. (This measures one carrier signal.) |

Detail Setting : Extended Freq Lock Range

■ Summary

Use this function for signal with large frequency difference. This function may make measurement possible.

Note :

This is available when Measurement Filter is set to Narrow.

■ Selection options

| | |
|-----|--|
| Off | Use this for normal signal. |
| On | Use this for signal with large frequency difference. |

Detail Setting: Cyclic Prefix Mode

■ Summary

Sets the Cyclic Prefix of the measurement target signal.

Note:

Available only when Measurement function is set to MIMO Summary.

■ Selection options

| | |
|----------|---|
| Normal | Use this to measure the Normal Cyclic Prefix signals. |
| Extended | Use this to measure the Extended Cyclic Prefix signals. |

Detail Setting: Time Offset Reference

■ Summary

Sets RS Time Offset Reference.

When Antenna is selected for Timing Offset Reference, RS Timing Offset displays the signal timing difference between the antenna port specified for Antenna Port and each antenna port.

When Ext. Trigger is selected for Timing Offset Reference, RS Timing Offset displays the signal timing difference between the trigger and each antenna port.

Note:

Available only when Measurement function is set to MIMO Summary.

■ Selection options

| | |
|--------------|--|
| Antenna | References the signals from the antenna port specified by Antenna Port |
| Ext. Trigger | References External Trigger |

PDSCH EVM Calculation

■ Summary

Specifies resource block that is PDSCH EVM calculation target. This parameter is applied only to the results for PDSCH ALL EVM, PDSCH QPSK EVEM, PDSCH 16QAM, and PDSCH 64QAM, PDSCH 256QAM displayed in Summary.

■ Selection options

3GPP This is the measurement method defined by 3GPP. When Channel Bandwidth is 1.4 MHz, the calculation target is only 2 pairs of resource block including 138 resource elements. When Channel Bandwidth is not 1.4 MHz, the calculation target is only 2 pairs of resource blocks including 150 resource elements.

All PDSCH Resource Elements

The calculation target is all resource elements allocated to PDSCH.

Table 3.6.1-3 shows the correspondences between the PDSCH EVM Calculation setting and the measurement result type.

Table 3.6.1-3 Correspondence between PDSCH EVM Calculation setting and measurement result type

| Measurement Result Types | Parameter PDSCH EVM Calculation | Measurement Target | Value Referenced as Ideal Signal Power During EVM Calculation |
|---|---------------------------------|--|---|
| PDSCH ALL EVM PDSCH QPSK EVM PDSCH 16QAM EVM PDSCH 64QAM EVM PDSCH 256QAM EVM | 3GPP | A set of two resource blocks that consist of PDSCH only | Power calculated using the ideal PDSCH symbol |
| | All PDSCH EVM Resource Elements | A set of all target PDSCH resource elements | Average power for the input reference signal |
| Power vs. RB EVM for specific resource block displayed in EVM vs. RB | 3GPP | All PDSCH resource elements included in the specified resource block | Power calculated using the ideal PDSCH symbol |
| | All PDSCH EVM Resource Elements | All PDSCH resource elements included in the specified resource block | Average power for the input reference signal |
| EVM for PDSCH included when calculating total EVM | – (Not applicable) | All PDSCH resource elements | Average power for the input reference signal |
| PDSCH EVM for specific OFDMA symbols and subcarriers (EVM displayed in EVM vs. Subcarrier and EVM vs. Symbol graphs) | – (Not applicable) | Specified PDSCH resource element | Average power for the input reference signal |

Virtual Resource Block type

■ Summary



This specifies the Virtual Resource Block Type.

■ Selection options

| | |
|-------------|---|
| Localized | The Power vs RB analysis results are displayed for each subframe. |
| Distributed | The Power vs RB analysis results are displayed for each slot. |

Detail Setting: Restore Default Values

■ Summary

To reset the parameters within the dialog box, press  (Restore Default Values) while the Detail Setting dialog box is displayed. However, the default values are not used for measurement until  (Set) is pressed.

PDCCH Mapping Load

■ Summary

Specifies the file to measure. This setting applies if PDCCH Mapping is set to Load File. If no file is specified, measurement is performed assuming PDCCH Mapping is Full.

■ Selection options

| | |
|-----------|--|
| Device | Specifies the drive that contains the file specified for PDCCH Mapping. |
| Load File | Selects the file specified for PDCCH Mapping. An XML file in the root directory of the drive specified for Device can be selected. |

3.6.1.1 Analysis Time

Set the measurement position in the Analysis Time function menu that is displayed by pressing **F1** (Analysis Time) on page 1 of the Modulation Analysis function menu or **Time/Sweep**.

The MX269020A captures data based on the value specified by Capture Time Length, and synchronizes the data in frame units. Also, the MX269020A analyzes the data in subframe units, and then displays the results. Specify the position to start synchronization for the captured data by using the Analysis Frame Position and Analysis Offset Time parameters. Specify the position to start analysis based on the synchronization point by using the Starting Subframe Number parameter. Specify the subframes to be analyzed by using the Measurement Interval parameter.

Starting Subframe Number

■ Summary

Sets the analysis starting position. In Figure 3.6.1.1-1, 3 is set for Starting Subframe Number.

■ Setting range

0 to 9

Measurement Interval

■ Summary

Sets the analysis Subframe length (Measurement Interval). Each measurement result is the value averaged at the interval set by this parameter. In Figure 3.6.1.1-1, 5 is set for Measurement Interval.

■ Setting range

1 to (10 – Starting Subframe Number)

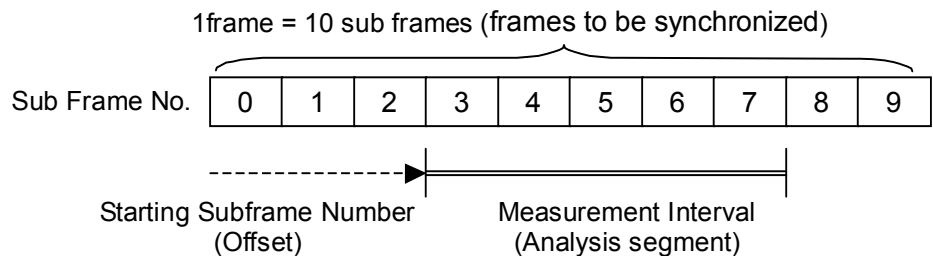

Figure 3.6.1.1-1 Starting Subframe Number and Measurement Interval settings

Analysis Frame Position

■ Summary

Sets the position to start analysis in frame units.

This setting is enabled when Capture Time is set to Manual.

If Storage Mode is set to Off, the setting range is determined assuming that the storage count is 1.

If the value of Capture Time Length or Storage Count is changed, this parameter is accordingly set within the setting range.

■ Setting range

0 to (Capture Time Length – Storage Count)

Analysis Offset Time

■ Summary

Sets the offset from the analysis start position set by Analysis Frame Position by time.

This setting is enabled when Capture Time is set to Manual. If Storage Mode is set to Off, the setting range is determined assuming that the storage count is 1.

If the value of Capture Time Length, Storage Count, or Analysis Frame Position is changed, this parameter is accordingly set within the setting range.

■ Setting range

0 for Analysis Frame Position, and same value for Capture Time Length and Storage Count:

0 ms (fixed)

0 for Analysis Frame Position, and larger value for Capture Time Length than Storage Count:

0 ms to 4.999999 ms

1 or larger for Analysis Frame Position, and same value for Capture Time Length and (Storage Count + Analysis Frame Position):

–4.999999 ms to 0 ms

Other than the above:

–4.999999 ms to 4.999999 ms

Figure 3.6.1.1-2 shows a parameter relationship example if Capture Time Length is set to 3, Analysis Frame Position is set to 1, Analysis Offset Time is set to a negative value, and Storage Count is set to 2.

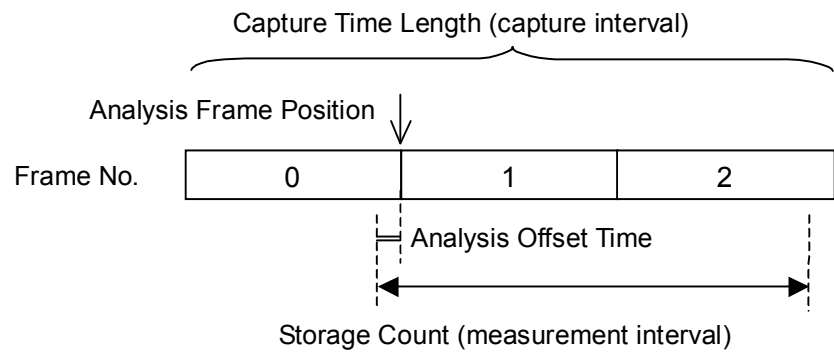

Figure 3.6.1.1-2 Analysis Frame Position and Analysis Offset Time settings

3.6.1.2 Trace (EVM vs Subcarrier, EVM vs Symbol, Spectral Flatness, RE Map)



Set Trace in the Trace function menu that is displayed by pressing  (Trace) on page 2 of the Modulation Analysis function menu or .

Table 3.6.1.2-1 Trace function menu

| Position | Menu Display | Function |
|-------------|-----------------------------|--|
| Page 1 [F1] | Trace Mode | Sets type of result displayed in a graph window. |
| Page 1 [F2] | Constellation Display Range | Sets the range of symbols to be displayed in a constellation. |
| Page 1 [F3] | Scale | Sets vertical scale of graphical result. |
| Page 1 [F5] | Storage | Sets storage method. |
| Page 1 [F6] | Subcarrier Number | Sets symbol number of Marker position and EVM vs Subcarrier displayed. |
| Page 1 [F7] | Symbol Number | Sets subcarrier number of Marker position and EVM vs Symbol displayed. |
| Page 1 [F8] | EVM vs Subcarrier View | Sets whether to enable averaging in EVM vs Subcarrier, and the display type. |
| | EVM vs Symbol View | Sets whether to enable averaging in EVM vs Symbol, and the display type. |
| | Spectral Flatness Type | Sets type of Spectral Flatness displayed. |

Trace Mode

■ Summary

Sets the type of result displayed in a graph window.

Note:

The Trace function menu configuration changes depending on the settings of this function.

■ Selection options

| | |
|-------------------------|--|
| EVM vs Subcarrier | Displays EVM vs Subcarrier in a graph window. |
| EVM vs Symbol | Displays EVM vs Symbol in a graph window. |
| Spectral Flatness | Displays Spectral Flatness in a graph window. |
| Power vs Resource Block | Displays Power vs Resource Block in a graph window. |
| EVM vs Resource Block | Displays EVM vs Resource Block in a graph window. |
| Summary | Displays EVM of each channel and power of each slot in a graph window. |
| Test Model Summary | Display Test Model signal measurement result in a graph window. |
| RE Map | Displays a layout map of resource blocks and elements in a graph window. |

Notes:

- Constellation is not displayed when Trace Mode is set to Summary or Test Model Summary.
- Trace Mode Summary is available when Test Model is not Off.

 3.5 "Common Setting Function Menu"

Constellation Display Range

■ Summary

Sets the range of symbols to be displayed in a constellation.

■ Selection options

| | |
|-----------|--|
| Symbol | Displays a constellation for the symbols specified for Symbol Number. |
| Composite | Displays a constellation for the symbols determined by the Starting Subframe Number and Measurement Interval parameters. |

Scale**■ Summary**

Sets vertical scale of graphical result.

■ Selection options

| | |
|----------------|--|
| EVM Unit | Sets a unit of EVM (% / dB) |
| EVM Scale | Sets the scale upper limit value of EVM in %: 1 to 100%, in dB: – 60 to 0 dB |
| Flatness Scale | Sets a scale of Spectral Flatness. |

Scale: Flatness Scale**■ Summary**

Sets a scale of Spectral Flatness.

■ Setting range

| | |
|----------------------|--|
| Amplitude | Sets the upper and lower limit values of Amplitude in Spectral Flatness (1.0 to 100.0 dB). |
| Difference Amplitude | Sets the upper and lower limit values of Difference Amplitude in Spectral Flatness (0.1 to 10.0 dB). |
| Phase | Sets the upper and lower limit values of Phase in Spectral Flatness (1.0 to 180.0 deg). |
| Group Delay | Sets the upper and lower limit values of Group Delay in Spectral Flatness (1.0 to 10000.0 dB). |

Storage**■ Summary**

Sets storage method. This setting is disabled when Capture Time is set to Manual and when Capture Time Length is set to 1.

■ Selection options

| | |
|-------|-----------------------------|
| Mode | Sets the storage mode. |
| Count | Sets the measurement count. |

Storage: Mode**■ Summary**

Sets the storage mode.

■ Selection options

| | |
|---------------|--|
| Off | Updates data per measurement. |
| Average | Displays the average per measurement. |
| Average & Max | Displays the average and maximum values per measurement. |

Storage: Count

■ Summary

Sets the measurement count.

■ Setting range

When Capture Time is Auto: 2 to 9999

When Capture Time is Manual: 2 to Capture Time Length

Subcarrier Number

■ Summary

Sets subcarrier number of Marker position and EVM vs Symbol displayed.

■ Setting range

| | |
|-----------|----------------------------|
| 0 to 1199 | Channel Bandwidth: 20 MHz |
| 0 to 899 | Channel Bandwidth: 15 MHz |
| 0 to 599 | Channel Bandwidth: 10 MHz |
| 0 to 299 | Channel Bandwidth: 5 MHz |
| 0 to 179 | Channel Bandwidth: 3 MHz |
| 0 to 71 | Channel Bandwidth: 1.4 MHz |

 3.5 "Common Setting Function Menu"

Symbol Number

■ Summary

Sets symbol number of marker position and the constellation displayed.

■ Setting range

0 to (Measurement Interval × 14 Symbol) - 1

 3.6.1.1 "Analysis Time"

EVM vs Subcarrier View

■ Summary

Sets whether to enable averaging in EVM vs Subcarrier, and the display type.

■ Selection options

Each Symbol Displays EVM vs Subcarrier of Symbol set in EVM vs Subcarrier Symbol Number.

Averaged over all Symbols Displays EVM vs Subcarrier of the analysis Subframe length set in Measurement Interval.

Graph View Selects a graph display type of EVM vs Subcarrier from the average (RMS), and the average value and peak value (RMS&Peak).

 3.6.1.1 "Analysis Time"

EVM vs Symbol View

■ Summary

Sets whether to enable averaging in EVM vs Symbol, and the display type.

■ Selection options

Each Subcarrier Displays EVM vs Symbol of Subcarrier set in EVM vs Symbol Subcarrier Number.

Averaged over all subcarriers Displays EVM vs Symbol in all subcarriers.

Graph View Selects a graph display type of EVM vs Subcarrier from the average (RMS), and the average value and peak value (RMS&Peak).

Spectral Flatness Type

■ Summary

Sets the type of Spectral Flatness displayed.

■ Selection options

Amplitude Displays Amplitude in Spectral Flatness.

Difference Amplitude Displays Difference Amplitude in Spectral Flatness.

Phase Displays Phase in Spectral Flatness.

Group Delay Displays Group Delay in Spectral Flatness.

3.6.1.3 Trace (Power vs Resource Block, EVM vs Resource Block)



Set Trace in the Trace function menu that is displayed by pressing  (Trace) on page 2 of the Modulation Analysis function menu or .

Table 3.6.1.3-1 Trace function menu

| Position | Menu Display | Function |
|-------------|-----------------------|--|
| Page 1 [F1] | Trace Mode | Sets a graphical result in the Graph window. |
| Page 1 [F3] | Scale | Sets vertical scale of a graphical result. |
| Page 1 [F4] | Storage | Sets the storage mode. |
| Page 1 [F6] | Subframe Number | Sets a subframe number. This is displayed when Virtual Resource Block Type is Localized. |
| | Slot Number | Sets the slot number. This is displayed when Virtual Resource Block type is Distributed. |
| Page 1 [F7] | Resource Block Number | Sets the resource block number. |
| Page 1 [F8] | Power vs RB View | Sets the display type of Power vs Resource Block. |
| | Graph View | Selects either average value (RMS) or average value and peak value (RMS&Peak) for the graph display type of EVM vs Resource Block. |

Trace Mode

■ Summary

Sets a graphical result in the Graph window.

Note:

The Trace function menu configuration changes depending on the settings of this function.

■ Selection options

EVM vs Subcarrier

Displays EVM vs Subcarrier in a graph window.

EVM vs Symbol

Displays EVM vs Symbol in a graph window.

Spectral Flatness

Displays Spectral Flatness in a graph window.

Power vs Resource Block

Displays Power vs Resource Block in a graph window.

EVM vs Resource Block

Displays EVM vs Resource Block in a graph window.

Summary

Displays EVM of each channel and power of each slot in a graph window.

RE Map

Displays a layout map of resource blocks and elements in a graph window.

Note:

The constellation is not displayed when Trace Mode is set to Summary.

Scale

■ Summary

Sets vertical scale of a graphical result.

■ Selection options

EVM Unit

Sets the unit of EVM (% / dB).

EVM Scale

Sets the upper limit for the EVM scale.
in %: 1 to 100%, in dB: – 60 to 0 dB

Note:

EVM Scale is valid only for EVM vs Resource Block.

Storage

■ Summary

Sets the storage mode. This setting is disabled when Capture Time is set to Manual and Capture Time Length is set to 1.

■ Selection options

Mode

Sets the storage mode.

Count

Sets the number of measurements.

Storage : Mode

■ Summary

Sets the storage mode.

■ Selection options

- | | |
|---------------|--|
| Off | Updates the data every time it measures. |
| Average | Displays the average value every time it measures. |
| Average & Max | Displays the average value and maximum value every time it measures. |

Storage : Count

■ Summary

Sets the number of measurements.

■ Setting range

When Capture Time is Auto:

2 to 9999

When Capture Time is set to Manual:

2 to Capture Time Length

Subframe Number

■ Summary

Sets the subframe number to be displayed for PDSCH Constellation and Bottom Graph.

Notes:

- This is displayed when Virtual Resource Block Type is Localized.
- This setting is common for Constellation and Bottom Graph.

■ Setting range

Starting Subframe Number to Starting Subframe Number + Measurement Interval -1

 3.6.1.1 “Analysis Time”

Slot Number

■ Summary

Sets the slot number to be displayed for PDSCH Constellation and Bottom Graph.

Notes:

- This is displayed when Virtual Resource Block type is Distributed.
- This setting applies to both Constellation and Bottom Graph.

■ Setting range

Starting Subframe Number $\times 2$
to (Starting Subframe Number + Measurement Interval) $\times 2 - 1$

Resource Block Number

■ Summary

Sets the resource block number.

Note:

This setting is common for Constellation and Bottom Graph.

■ Setting range

| | |
|---------|----------------------------|
| 0 to 99 | Channel Bandwidth: 20 MHz |
| 0 to 74 | Channel Bandwidth: 15 MHz |
| 0 to 49 | Channel Bandwidth: 10 MHz |
| 0 to 24 | Channel Bandwidth: 5 MHz |
| 0 to 14 | Channel Bandwidth: 3 MHz |
| 0 to 5 | Channel Bandwidth: 1.4 MHz |

 3.5 “Common Setting Function Menu”

Power vs RB View

■ Summary

Sets the display type of Power vs Resource Block.

Note:

This setting is enabled only for Power vs Resource Block.

■ Selection options

| | |
|---------------|---|
| Each Subframe | Displays Power vs Resource Block of the subframe set by Subframe Number. |
| Overall | Displays Power vs Resource Block for all subframes. |
| Graph View | Selects either average value (RMS) or average value and peak value (RMS&Peak) for the EVM display type. |

Graph View

■ Summary

Selects either average value (RMS) or average value and peak value (RMS&Peak) for the graph display type of EVM vs Resource Block.

Note:

When Trace Mode is set to Power vs Resource Block, the setting is for the display type of MKR EVM.

■ Selection options

| | |
|----------|---|
| RMS | Displays the average value of EVM vs Resource Block. |
| RMS&Peak | Displays the average value and peak value of EVM vs Resource Block. |

3.6.1.4 Trace (Summary)



Set Trace in the Trace function menu that is displayed by pressing  (Trace) on page 2 of the Modulation Analysis function menu or .

Table 3.6.1.4-1 Trace function menu

| Position | Menu Display | Function |
|-------------|--------------|--|
| Page 1 [F1] | Trace Mode | Sets a graphical result in the Graph window. |
| Page 1 [F3] | Scale | Sets a unit of EVM. |
| Page 1 [F4] | Storage | Sets the result storage method. |
| Page 1 [F8] | Page Number | Sets the page number to be displayed. |

Trace Mode

■ Summary

Sets a graphical result in the Graph window.

Note:

The Trace function menu configuration changes depending on the settings of this function.

■ Selection options

EVM vs Subcarrier

Displays EVM vs Subcarrier in a graph window.

EVM vs Symbol

Displays EVM vs Symbol in a graph window.

Spectral Flatness

Displays Spectral Flatness in a graph window.

Power vs Resource Block

Displays Power vs Resource Block in a graph window.

EVM vs Resource Block

Displays EVM vs Resource Block in a graph window.

Summary

Displays EVM of each channel and power of each slot in a graph window.

RE Map

Displays a layout map of resource blocks and elements in a graph window.

Note:

The constellation is not displayed when Trace Mode is set to Summary.

Scale

■ Summary

Sets vertical scale of a graphical result.

■ Selection options

EVM Unit Sets a unit of EVM (% / dB)

Storage

■ Summary

Sets the result storage method. This setting is disabled when Capture Time is set to Manual AND when Capture Time Length is set to 1.

■ Selection options

Mode Sets the storage mode.
Count Sets the number of measurements.

Storage: Mode

■ Summary

Sets the storage mode.

■ Selection options

Off Updates the data every time it measures.
Average Displays the average value every time it measures.
Average & Max Displays the average value and maximum value every time it measures.

Storage: Count

■ Summary

Sets the number of measurements.

■ Setting range

When Capture Time is Auto: 2 to 9999
When Capture Time is Manual: 2 to Capture Time Length

Page Number

■ Summary

Sets the page number.

■ Setting range

1 to 9

3.6.2 MIMO Summary





Set the analysis items for MIMO signal in the MIMO Summary function menu that is displayed by pressing  (MIMO Summary) in the Measure menu.

Table 3.6.2-1 MIMO Summary function menu

| Position | Menu display | Function |
|----------|--------------------------|---|
| [F1] | Analysis Time | Sets measurement position. Shares modulation analysis and setting values.  3.6.1.1 “Analysis Time” |
| [F3] | Channel Bandwidth | Sets Channel Bandwidth. Shares modulation analysis and setting values.  3.5 “Common Setting Function Menu” |
| [F7] | Detail Settings | Sets details of measured signal. Shares modulation analysis and setting values.  3.6.1 “Modulation Analysis” |
| [F8] | Active Antenna Threshold | Sets a signal detection level. |

Active Antenna Threshold

■ Summary

Sets the threshold value for On/Off evaluation of the Antenna Port signal. The RS power of the set Antenna Port signal is used as the reference to evaluate the RS power of the signal of each Antenna Port.

■ Setting range

–100 to 0 dB

3.6.3 Adjacent Channel Power Measurement (ACP)

The ACP function of the Signal Analyzer function or Spectrum Analyzer function is recalled by automatically reflecting the settings of Carrier Frequency, Input level, Offset, Offset Value, and Pre-Amp to the corresponding parameters. Recall Current Application described in Section 3.6.2 “Recalling parameters” of the *MS2690A/MS2691A/MS2692A Operation Manual (Mainframe Operation)* or *MS2830A Operation Manual (Mainframe Operation)* cannot be executed when this function is being recalled.

ACP (FFT)

■ Summary

Recalls the ACP function of the Signal Analyzer function and measures the adjacent channel power for the reflected parameter settings. ACP (FFT) is enabled only when a Channel Bandwidth is set to 1.4, 3, or 5 MHz.

ACP (Swept)

■ Summary

Recalls the ACP function of the Spectrum Analyzer function and measures the adjacent channel leakage power for the reflected parameter settings.

3.6.4 Channel Power Measurement (Channel Power)

The Channel Power function of the Signal Analyzer function or Spectrum Analyzer function is recalled by automatically reflecting the settings of Carrier Frequency, Input level, Offset, Offset Value and Pre-Amp to the corresponding parameters. Recall Current Application described in Section 3.6.2 “Recalling parameters” of the *MS2690A/MS2691A/MS2692A Operation Manual (Mainframe Operation)* or *MS2830A Operation Manual (Mainframe Operation)* cannot be executed when this function is being recalled.

Channel Power (FFT)

■ Summary

Recalls the Channel Power function of the Signal Analyzer function and measures the channel power for the reflected parameter settings.

Channel Power (Swept)

■ Summary

Recalls the Channel Power function of the Spectrum Analyzer function and measures the channel power for the reflected parameter settings.

3.6.5 Occupied Bandwidth Measurement (OBW)

The OBW function of the Signal Analyzer function or Spectrum Analyzer function is recalled by automatically reflecting the settings of Carrier Frequency, Input level, Offset, Offset Value, and Pre-Amp to the corresponding parameters. Recall Current Application described in Section 3.6.2 “Recalling parameters” of the *MS2690A/MS2691A/MS2692A Operation Manual (Mainframe Operation)* or *MS2830A Operation Manual (Mainframe Operation)* cannot be executed when this function is being recalled.

OBW (FFT)

■ Summary

Recalls the OBW function of the Signal Analyzer function and measures the occupied bandwidth for the reflected parameter settings.

OBW (Swept)

■ Summary

Recalls the OBW function of the Spectrum Analyzer function and measures the occupied bandwidth for the reflected parameter settings.

3.6.6 Spectrum Emission Mask Measurement (SEM)

The Spectrum Emission Mask function of the Spectrum Analyzer function is recalled by automatically reflecting the settings of Carrier Frequency, Input level, Offset, Offset Value, and Pre-Amp to the corresponding parameters. Recall Current Application described in Section 3.6.2 “Recalling parameters” of the *MS2690A/MS2691A/MS2692A Operation Manual (Mainframe Operation)* or *MS2830A Operation Manual (Mainframe Operation)* cannot be executed when this function is being recalled.

Spectrum Emission Mask (Swept)

■ Summary

Recalls the Spectrum Emission Mask function of the Signal Analyzer function and measures the spectrum emission mask for the reflected parameter settings.

3.6.7 Advanced Settings

This allows you to configure various settings related to the measurement functions.

Coupled Ref & ATT in Swept & FTT

■ Summary

This command sets whether to inherit ATT setting when switching function among the followings:

- ACP of Spectrum analyzer function
- Channel Power
- OBW
- Spectrum Emission Mask (SEM)
- ACP
- Channel Power
- OBW

ATT setting may not be inherited when function is switched among Modulation Analysis and MIMO measurement.

3.6.8 Batch Measurement

Set the batch measurement parameters in the Batch Measurement function menu that is displayed by pressing **Batch Measurement** on the Measure function menu.

Table 3.6.8-1 Batch Measurement function menu

| Position | Menu Display | |
|-------------|----------------|--|
| Page 1 [F1] | Batch Settings | Sets the Batch Measurement parameters.  3.6.8.1 "Batch Settings" |



3.6.8.1 Batch Settings

This menu is used to set the batch measurement parameters.

Common Settings: Storage Mode

■ **Summary**

Sets the storage mode of Modulation Analysis.

■ **Selection options**

- Off Updates data per measurement.
- Average Displays the average per measurement.
- Average & Max Displays the average and maximum values per measurement.

Common Settings: Storage Count

■ **Summary**

Sets the measurement count of Modulation Analysis.

■ **Setting range**

2 to 9999

Common Settings: Storage Mode for Unwanted Emissions

■ **Summary**

Sets the storage mode for Unwanted Emissions.

■ **Selection options**

- Off Updates data per measurement.
- Average Displays the average per measurement.

Common Settings: Storage Count for Unwanted Emissions

■ **Summary**

Sets the measurement count for Unwanted Emissions.

■ **Setting range**

2 to 9999

Common Settings: Starting Subframe Number

■ Summary

Sets the analysis starting position of Modulation Analysis.

■ Setting range

0 to 9

Common Settings: Measurement Interval

■ Summary

Sets the analysis subframe length (Measurement Interval) of Modulation Analysis. Each measurement result is the value averaged at the interval set by this parameter.

■ Setting range

1 to (10 – Common Settings: Starting Subframe Number)

Common Settings: Starting OFDM Symbol Number

■ Summary

Sets the analysis starting position of Unwanted Emissions.

■ Setting range

0 to 139

Common Settings: Measurement Interval for Unwanted Emissions

■ Summary

Sets the analysis OFDM Symbol length of Unwanted Emissions. Each measurement result is the value averaged at the interval set by this parameter.

■ Setting range

1 to (140 – Common Settings : Starting OFDM Symbol Number)

Common Settings: Modulation Analysis

■ Summary

Enables/disables of Modulation Analysis.

■ Selection options

| | |
|-----|----------------------------------|
| Off | Disables the Modulation Analysis |
| On | Enables the Modulation Analysis |

Common Settings: OBW**■ Summary**

Enables/disables of OBW measurement. The measurement is not executed if the required frequency bandwidth exceeds the analysis bandwidth.

■ Selection options

| | |
|-----|------------------------------|
| Off | Disables the OBW measurement |
| On | Enables the OBW measurement |

Common Settings: ACLR (Adjacent Channel Leakage Ratio)**■ Summary**

Enables/disables of ACLR measurement. The measurement is not executed if the required frequency bandwidth exceeds the analysis bandwidth.

■ Selection options

| | |
|-----|-------------------------------|
| Off | Disables the ACLR measurement |
| On | Enables the ACLR measurement |

Common Settings: OBUE (Operating Band Unwanted Emissions)**■ Summary**

Enables/disables of OBUE measurement. The measurement is not executed if the required frequency bandwidth exceeds the analysis bandwidth.

■ Selection options

| | |
|-----|-------------------------------|
| Off | Disables the OBUE measurement |
| On | Enables the OBUE measurement |

Band Settings: Measurement Item**■ Summary**

Sets the measurement items for every Band.

■ Setting items

| | |
|---------|----------------------|
| Band #0 | Measures the Band 0. |
| Band #1 | Measures the Band 1. |
| Band #2 | Measures the Band 2. |

Notes:

- When the MX269020A-001 is not installed, this is fixed to Band 0.
- When MS2830A-078 is installed to the mainframe, this is fixed to Band 0.

Band Settings: Carrier Frequency

■ Summary

Sets a carrier frequency.

■ Setting range

30 MHz to the upper limit of the main unit

(When MS269xA-004/104/078/178 or MS2830A-078 are not installed)

100 MHz to the upper limit of the main unit

(When MS269xA-004/104/078/178 are installed to the mainframe)

300 MHz to the upper limit of the main unit

(When MS2830A-078 is installed to the mainframe)

Band Settings: Input Level

■ Summary

Sets the input level from the target DUT.

■ Setting range

For Pre-Amp: On :

(-80.00 + Offset Value) to (10.00 + Offset Value) dBm

For Pre-Amp: Off:

(-60.00 + Offset Value) to (30.00 + Offset Value) dBm

Band Settings: Pre-Amp

■ Summary

Sets On/Off for the Pre-Amp function.

■ Selection options

On Enables the Pre-Amp function.

Off Disables the Pre-Amp function.

Band Settings: Offset

■ Summary

Sets On/Off for the offset function.

■ Selection options

On Enables the offset function.

Off Disables the offset function.

Band Settings: Offset Value

■ Summary

Sets the level offset coefficient.

■ Setting range

-99.99 to 99.99 dB

Band Settings: Contiguous Mode

■ Summary

Sets On/Off for the contiguous mode.

■ Selection options

| | |
|-----|-------------------------------|
| On | Enables the Contiguous Mode. |
| Off | Disables the Contiguous Mode. |

Note:

When the MX269020A-001 is not installed, it is fixed to Off.

Band Settings: OBUE Standard

■ Summary

Sets the standard template for OBUE measurement.

■ Selection options

| | |
|-------------------------|---------------------------------------|
| WideBS Cat.A<1G | Wide Area BS Category A <1G |
| WideBS Cat.A 1-3G | Wide Area BS Category A 1-3G |
| WideBS Cat.A >3G | Wide Area BS Category A >3G |
| WideBS Cat.B Opt.1 <1G | Wide Area BS Category B Option 1 <1G |
| WideBS Cat.B Opt.1 1-3G | Wide Area BS Category B Option 1 1-3G |
| WideBS Cat.B Opt.1 >3G | Wide Area BS Category B Option 1 >3G |
| WideBS Cat.B Opt.2 | Wide Area BS Category B Option 2 |
| LocalBS Cat.A&B ≤3G | Local Area BS Category A&B ≤3G |
| LocalBS Cat.A&B >3G | Local Area BS Category A&B >3G |
| HomeBS Cat.A&B ≤3G | Home BS Category A&B ≤3G |
| HomeBS Cat.A&B >3G | Home BS Category A&B >3G |

Band Settings: OBUE Standard Additional

■ Summary

Sets the additional standard template for OBUE measurement.

■ Selection options

| | |
|---------------------------|---|
| Off | Not use the additional standard template. |
| Band 5 | Band 5 |
| Band2,4,10,23,25,35,36,41 | Band2, 4, 10, 23, 25, 35, 36, 41 |
| Band12,13,14,17 | Band12, 13, 14, 17 |

CC Settings: Measurement Item

■ Summary

Sets the measurement items for every CC.

■ Setting items

| | |
|-------|--------------------|
| CC #0 | Measures the CC 0. |
| CC #1 | Measures the CC 1. |
| CC #2 | Measures the CC 2. |
| CC #3 | Measures the CC 3. |
| CC #4 | Measures the CC 4. |

■ Default

When the MX269020A-001 is installed, and the MS269xA-004/104/078/178 or MS2830A-078 is installed:

| | |
|-------------|-----|
| CC #0 | On |
| CC #1,2,3,4 | Off |

When the MX269020A-001 is installed, but the MS269xA-004/104/078/178 or MS2830A-078 is not installed:

| | |
|-----------|-----------|
| CC #0,1,2 | On fixed |
| CC #3,4 | Off fixed |

When the MX269020A-001 is not installed:

| | |
|-------------|-----------|
| CC #0 | On fixed |
| CC #1,2,3,4 | Off fixed |

CC Settings: Frequency Band

■ Summary

Sets the frequency band.

■ Setting items

| | |
|---------|-------------------------------|
| Band #0 | Measures as the CC of Band 0. |
| Band #1 | Measures as the CC of Band 1. |
| Band #2 | Measures as the CC of Band 2. |

Notes:

- When the MX269020A-001 is not installed, this is fixed to Band 0.
- When MS2830A-078 is installed to the mainframe, this is fixed to Band 0.

CC Settings: Frequency Offset**■ Summary**

Sets the frequency offset.

■ Setting range

–50000000 + (CC Settings: Channel Bandwidth / 2) to
50000000 – (CC Settings: Channel Bandwidth / 2) Hz
(When MS269xA-004/104/078/178 or MS2830A-078 are installed.)

–15625000 + (CC Settings: Channel Bandwidth / 2) to
15625000 – (CC Settings: Channel Bandwidth / 2) Hz
(When MS269xA-004/104/078/178 or MS2830A-078 are not installed.)

Notes:

- When the MX269020A-001 is not installed, it is fixed to 0 Hz.
- The resolution is 300 kHz when Band Settings: Contiguous Mode is set to On.
- The resolution is 1 kHz when Band Settings: Contiguous Mode is set to Off.

CC Settings: Channel Bandwidth**■ Summary**

Selects a band of an input signal.

■ Selection options

| | |
|---------|---|
| 1.4 MHz | Analyzes an input signal as a 1.4 MHz band. |
| 3 MHz | Analyzes an input signal as a 3 MHz band. |
| 5 MHz | Analyzes an input signal as a 5 MHz band. |
| 10 MHz | Analyzes an input signal as a 10 MHz band. |
| 15 MHz | Analyzes an input signal as a 15 MHz band. |
| 20 MHz | Analyzes an input signal as a 20 MHz band. |

CC Settings: Test Model**■ Summary**

Selects the type of the test model defined in 3GPP TS36.141.

■ Selection options

| | |
|----------|---|
| Off | Selects when measuring signals other than the test model. |
| E-TM1.1 | Selects when measuring E-TM1.1 signals. |
| E-TM1.2 | Selects when measuring E-TM1.2 signals. |
| E-TM2 | Selects when measuring E-TM2 signals. |
| E-TM2a | Selects when measuring E-TM2a signals. |
| E-TM3.1 | Selects when measuring E-TM3.1 signals. |
| E-TM3.1a | Selects when measuring E-TM3.1a signals. |

- E-TM3.2 Selects when measuring E-TM3.2 signals.
- E-TM3.3 Selects when measuring E-TM3.3 signals.

CC Settings: Synchronization Mode

■ Summary

Sets the synchronized signal.

■ Selection options

- SS Sets Synchronization Signal for the synchronized signal.
- RS Sets Reference Signal for the synchronized signal.

Note:

Available when CC Settings: Test Model is set to Off.

CC Settings: Reference Signal Mode

■ Summary

Sets the reference signal mode.

■ Selection options

- Auto Determines the Reference Signal through automatic judgment.
- Using Cell ID Determines the Reference Signal according to the Cell ID setting.

Note:

Auto can be selected only when CC Settings: Synchronization Mode is set to Synchronization Signal.

CC Settings: Cell ID

■ Summary

Sets the Cell ID of the Reference Signal. This setting is enabled when CC Settings: Reference Signal Mode is set to Using Cell ID.

■ Setting range

0 to 503

CC Settings: CRS Power Boosting

■ Summary

Sets the boost level of the CRS.

■ Setting range

-20.000 to +20.000 dB

CC Settings: CRS Number of Antenna Ports**■ Summary**

Sets the number of antennas for the CRS.

■ Selection options

- | | |
|---|--|
| 1 | Analyzes under the condition that the number of antennas used for transmission is 1. |
| 2 | Analyzes under the condition that the number of antennas used for transmission is 2. |
| 4 | Analyzes under the condition that the number of antennas used for transmission is 4. |

CC Settings: CSI-RS Number of Antenna Ports**■ Summary**

Sets the number of antennas for the CSI-RS.

■ Selection options

- | | |
|---|--|
| 1 | Analyzes under the condition that the number of antennas used for transmission is 1. |
| 2 | Analyzes under the condition that the number of antennas used for transmission is 2. |
| 4 | Analyzes under the condition that the number of antennas used for transmission is 4. |
| 8 | Analyzes under the condition that the number of antennas used for transmission is 8. |

Note:

This can be set when CC Settings: CSI-RS On/Off is checked.

CC Settings: CRS Antenna Port**■ Summary**

Sets the antenna port number to be measured.

■ Setting range

0 to CRS Number of Antenna Ports – 1

CC Settings: CSI-RS Antenna Port**■ Summary**

Sets the antenna port number to be measured.

■ Setting range

15 to CSI-RS Number of Antenna Ports + 14

Note:

This can be set when CC Settings: CSI-RS On/Off is checked.

CC Settings: PDSCH Modulation Scheme

■ Summary

Sets PDSCH Modulation Scheme.

Select AUTO if the measurement target includes multiple modulation schemes.

■ Selection options

- QPSK Analyzes an input signal as a QPSK modulated signal.
- 16QAM Analyzes an input signal as a 16QAM modulated signal.
- 64QAM Analyzes an input signal as a 64QAM modulated signal.
- 256QAM Analyzes an input signal as a 256QAM modulated signal.
- AUTO Analyzes an input signal after judging its modulation scheme automatically (Excluding 256QAM).

CC Settings: EVM Window Length

■ Summary

Sets FFT window length. There are two setting methods: Ts and W.

If the CC Settings: Channel Bandwidth is changed, the setting is restored to the default value according to the CC Settings: Channel Bandwidth. (See Table 3.6.1-2.)

■ Setting range

- Ts 0 to 142
- W When CC Settings: Channel Bandwidth is set to 1.4 MHz: 0 to 8
When CC Settings: Channel Bandwidth is set to 3 MHz: 0 to 17
When CC Settings: Channel Bandwidth is set to 5 MHz: 0 to 35
When CC Settings: Channel Bandwidth is set to 10 MHz: 0 to 71
When CC Settings: Channel Bandwidth is set to 15 MHz: 0 to 106
When CC Settings: Channel Bandwidth is set to 20 MHz: 0 to 142

CC Settings: Channel Estimation

■ Summary

Sets the Channel Estimation function to On/Off.

■ Selection options

- Checked Enables the Channel Estimation function.
- Non-Checked Disables the Channel Estimation function.

CC Settings: Measurement Filter Type**■ Summary**

Selects filter type used for modulation analysis.

■ Selection options

| | |
|--------|--|
| Normal | Use this when measuring single carrier signal. |
| Narrow | Use this when measuring multi-carrier signal. (This measures one carrier signal.) |

Notes :

- This can be set when Band Settings: Contiguous Mode is set to Off.
- Even if Narrow is selected, this function measures only one carrier signal.
- For the internal processing, the wideband filter intended for Carrier Aggregation is selected.

CC Settings: PBCH On/Off**■ Summary**

Selects whether to include PBCH for the target measurement.
Available when CC Settings: Test Model is set to Off.

■ Selection options

| | |
|-------------|---|
| Checked | Target measurement includes PBCH. |
| Non-Checked | Target measurement does not include PBCH. |

CC Settings: PBCH Power Boosting (Auto/Manual)**■ Summary**

Selects whether to detect PBCH power automatically or manually.
Available when CC Settings: Test Model is set to Off and CC Settings: PBCH is set to On.

■ Selection options

| | |
|--------|---------------------|
| Auto | Automatic detection |
| Manual | Manual detection |

CC Settings: PBCH Power Boosting**■ Summary**

Sets a value relative to the reference signal level to the PBCH level .
This setting is enabled when CC Settings: PBCH is set to On and
when CC Settings: PBCH Power Boosting is set to Manual.

■ Setting range

-20.000 to +20.000 dB

CC Settings: P-SS On/Off

■ Summary

Selects whether the measurement target includes the primary synchronization signal. This parameter is fixed ON if Synchronization Signal is selected for Synchronization Mode.

Available when CC Settings: Test Model is set to Off.

■ Selection options

Checked The measurement target includes P-SS.

Non-Checked The measurement target does not include P-SS.

CC Settings: P-SS Power Boosting (Auto/Manual)

■ Summary

Selects whether to detect the primary synchronization signal power automatically or manually.

Available when CC Settings: Test Model is set to Off and CC Settings: P-SS is set to On.

■ Selection options

Auto Automatic detection

Manual Manual detection

CC Settings: P-SS Power Boosting

■ Summary

Sets a value relative to the reference signal level to the primary synchronization signal level.

This setting is enabled when CC Settings: P-SS is set to On and when CC Settings: P-SS Power Boosting is set to Manual.

■ Setting range

-20.000 to +20.000 dB

CC Settings: S-SS On/Off

■ Summary

Select whether the measurement target includes the secondary synchronization signal. The check box is always selected if Synchronization Signal is selected for Synchronization Mode.

Available when CC Settings: Test Model is set to Off.

■ Selection options

Checked The measurement target includes S-SS.

Non-Checked The measurement target does not include S-SS.

CC Settings: S-SS Power Boosting (Auto/Manual)**■ Summary**

Selects whether to detect the secondary synchronization signal power automatically or manually.

Available when CC Settings: Test Model is set to Off and CC Settings: S-SS is set to On.

■ Selection options

| | |
|--------|---------------------|
| Auto | Automatic detection |
| Manual | Manual detection |

CC Settings: S-SS Power Boosting**■ Summary**

Sets a value relative to the reference signal level to the secondary synchronization signal level. This setting is enabled when CC Settings: S-SS is set to On and when CC Settings: S-SS Power Boosting is set to Manual.

■ Setting range

-20.000 to +20.000 dB

CC Settings: PDCCH On/Off**■ Summary**

Select whether the measurement target includes PDCCH.
Available when CC Settings: Test Model is set to Off.

■ Selection options

| | |
|-------------|--|
| Checked | The measurement target includes PDCCH. |
| Non-Checked | The measurement target does not include PDCCH. |

CC Settings: PDCCH Power Boosting (Auto/Manual)**■ Summary**

Selects whether to detect the PDCCH power automatically or manually.

Available when CC Settings: PDCCH is set to On and CC Settings: PDCCH Mapping - Number of PDCCHs is more than 1.

■ Selection options

| | |
|--------|---------------------|
| Auto | Automatic detection |
| Manual | Manual detection |

CC Settings: PDCCH Power Boosting

■ Summary

Sets a value relative to the reference signal level to the PDCCH level. This setting is enabled if CC Settings: PDCCH is On and CC Settings: PDCCH Power Boosting is set to Manual.

■ Setting range

-20.000 to +20.000 dB

CC Settings: PCFICH On/Off

■ Summary

Select whether the measurement target includes PCFICH. Available when CC Settings: Test Model is set to Off.

■ Selection options

| | |
|-------------|---|
| Checked | The measurement target includes PCFICH. |
| Non-Checked | The measurement target does not include PCFICH. |

CC Settings: PCFICH Power Boosting (Auto/Manual)

■ Summary

Selects whether to detect the PCFICH power automatically or manually. Available when CC Settings: Test Model is set to Off and CC Settings: PCFICH is set to On.

■ Selection options

| | |
|--------|---------------------|
| Auto | Automatic detection |
| Manual | Manual detection |

CC Settings: PCFICH Power Boosting

■ Summary

Sets a value relative to the reference signal level to the PCFICH level. This setting is enabled when CC Settings: PCFICH is set to On and when CC Settings: PCFICH Power Boosting is set to Manual.

■ Setting range

-20.000 to +20.000 dB

CC Settings: PHICH On/Off**■ Summary**

Select whether the measurement target includes PHICH.
Available when CC Settings: Test Model is set to Off.

■ Selection options

| | |
|-------------|---|
| Checked | The measurement target includes PCHICH. |
| Non-Checked | The measurement target does not include PCHICH. |

CC Settings: PHICH Power Boosting (Auto/Manual)**■ Summary**

Selects whether to detect the power of the PHICH group automatically or manually. Available when CC Settings: Test Model is set to Off and CC Settings: PHICH is set to On.

■ Selection options

| | |
|--------|-------------------|
| Auto | Automatic setting |
| Manual | Manual setting |

CC Settings: PHICH Power Boosting**■ Summary**

Sets a value relative to the reference signal level to the level of the PHICH group.
This setting is enabled when CC Settings: PHICH is set to On and when CC Settings: PHICH Power Boosting is set to Manual.

■ Setting range

-20.000 to +20.000 dB

CC Settings: PDSCH Power Boosting (Auto/Manual)**■ Summary**

This selects automatic detection and manual setting of the PDSCH power. Available when CC Settings: PDSCH is set to On.

■ Selection options

| | |
|--------|------------------------|
| Auto | Detects automatically. |
| Manual | Sets manually. |

CC Settings: PDSCH Power Boosting

■ Summary

Sets value relative to reference signal level at PDSCH level. This is enabled only when CC Settings: PDSCH Power Boosting is set to Manual.

■ Setting range

-20.000 to +20.000 dB

CC Settings: PHICH Ng

■ Summary

Sets a parameter (Ng) to determine the number of PHICH groups. This setting is enabled when CC Settings: PHICH is set to On.

■ Selection options

| | |
|-----|--------------------|
| 1/6 | 1/6 is set for Ng. |
| 1/2 | 1/2 is set for Ng. |
| 1 | 1 is set for Ng. |
| 2 | 2 is set for Ng. |

CC Settings: PHICH Duration

■ Summary

Sets the PHICH duration. This setting is enabled when CC Settings: PHICH is set to On.

■ Selection options

| | |
|----------|----------|
| Normal | Normal |
| Extended | Extended |

CC Settings: Number of PDCCH Symbols (Auto/Manual)

■ Summary

Selects whether to detect the number of PDCCH symbols automatically or manually. The automatic detection is performed by decoding PCFICH. This setting is enabled when CC Settings: PCFICH is set to On and CC Settings: PDCCH is set to On.

■ Selection options

| | |
|--------|---------------------|
| Auto | Automatic detection |
| Manual | Manual detection |

CC Settings: Number of PDCCH Symbols**■ Summary**

Sets the Symbol number of PDCCH. This setting is enabled when CC Settings: Test Model is set to Off, CC Settings: PDCCH is set to On and CC Settings: Number of PDCCH Symbols is set to Manual.

■ Setting range

When CC Settings: Channel Bandwidth is set to 1.4 MHz:

0 to 4

When CC Settings: Channel Bandwidth is set to other than 1.4 MHz:

0 to 3

CC Settings: PDCCH Mapping**■ Summary**

Sets mapping of PDCCH and NIL (dummy PDCCH) to the control channel elements (CCEs). This setting is enabled when CC Settings: Test Model is set to Off and CC Settings: PDCCH is set to On.

■ Setting range

| | |
|------|---|
| Auto | Automatically evaluates and measures PDCCH and NIL |
| Full | Performs measurement assuming that only PDCCHs are mapped (no NIL). Even if REG is a value smaller than the CCE unit, measurement is performed assuming that PDCCHs are mapped. |
| Easy | Performs measurement for all subframes according to the PDCCH mapping that is determined by the PDCCH Format and Number of PDCCHs parameters. Measurement is performed assuming that PDCCHs are mapped sequentially from the first CCE for the number specified by Number of PDCCHs in the unit specified by PDCCH Format. |

CC Settings: PDCCH Mapping - PDCCH Format**■ Summary**

Sets the type of PDCCH format. This setting is enabled when CC Settings: PDCCH is set to On and CC Settings: PDCCH Mapping is set to Easy.

■ Setting range

0 to 3

CC Settings: PDCCH Mapping - Number of PDCCHs

■ Summary

Sets the number of PDCCHs to be mapped. This setting is enabled when CC Settings: PDCCH is set to On and CC Settings: PDCCH Mapping is set to Easy.

PDCCHs are mapped sequentially from CCE(0) for the number specified by this parameter, in the unit specified by PDCCH Format. If a value greater than the number of PDCCHs that can be mapped is specified, measurement is performed assuming that PDCCHs are mapped to all CCEs to which PDCCHs can be mapped.

■ Setting range

1 to 88

CC Settings: CSI-RS On/Off

■ Summary

Select whether the measurement target includes CSI-RS. Available when CC Settings: Test Model is set to Off.

■ Selection options

| | |
|-------------|---|
| Checked | The measurement target includes CSI-RS. |
| Non-Checked | The measurement target does not include CSI-RS. |

Note :

When the MX269020A-001 is not installed, it is fixed to Non-Checked.

CC Settings: CSI-RS Configuration

■ Summary

Sets CSI-RS Configuration.

■ Setting range

When CSI-RS Number of Antenna Ports is set to 8: 0 to 4
When CSI-RS Number of Antenna Ports is set to 4: 0 to 9
When CSI-RS Number of Antenna Ports is set to 2: 0 to 19
When CSI-RS Number of Antenna Ports is set to 1: 0 to 19

Note :

This can be set when CC Settings: CSI-RS On/Off is checked.

CC Settings: CSI-RS Periodicity T

■ Summary

Sets CSI-RS Periodicity T.

■ Selection options

- 5 Measures with CSI-RS Periodicity T set to 5.
- 10 Measures with CSI-RS Periodicity T set to 10.

Note :

This can be set when CC Settings: CSI-RS On/Off is checked.

CC Settings: CSI-RS Subframe Offset

■ Summary

Sets CSI-RS Subframe Offset.



■ Setting range

- When CSI-RS Periodicity T is set to 10: 0 to 9
- When CSI-RS Periodicity T is set to 5: 0 to 4

Note :

This can be set when CC Settings: CSI-RS On/Off is checked.

3.7 Setting Marker

Configure the marker settings in the Marker function menu that is displayed by pressing  (Marker) on the main function menu or . Also, press  to display page 2 of the Marker function menu.

The Marker function menu consists of 2 pages that are toggled by pressing .

Note:

When Trace Mode is set to Summary, settings related to the marker function cannot be configured.

Marker

■ Summary

Sets On/Off for the marker function.

■ Selection options

- On Enables the marker function.
- Off Disables the marker function.

Subcarrier Number

■ Summary

Sets the position of the subcarrier targeted for the marker.

■ Setting range

When the Trace Mode is EVM vs Subcarrier, EVM vs Symbol, Spectral Flatness, or RE Map:

- 0 to 1199 Channel Bandwidth: 20 MHz
- 0 to 899 Channel Bandwidth: 15 MHz
- 0 to 599 Channel Bandwidth: 10 MHz
- 0 to 299 Channel Bandwidth: 5 MHz
- 0 to 179 Channel Bandwidth: 3 MHz
- 0 to 71 Channel Bandwidth: 1.4 MHz

 3.5 “Common Setting Function Menu”

When the Trace Mode is Power vs Resource Block or EVM vs Resource Block:

Cannot be set. The subcarrier number set for Subframe Number or the number for the resource element determined by the Slot Number and Resource Block Number parameters is displayed.

Note:

The subcarrier number might be out of the graph display range for Difference Amplitude and Group Delay in Spectral Flatness. In this case, the marker is displayed at the minimum or maximum value of the graph display range.

Symbol Number

■ Summary

Sets the position of the symbol targeted for the marker.

■ Setting range

0 to (Measurement Interval × 14 Symbol) – 1

 3.6.1.1 “Analysis Time”

Subframe Number

■ Summary

Sets the subframe number to be displayed for PDSCH Constellation and Bottom Graph.

Notes:

- This is displayed when Virtual Resource Block Type is Localized.
- This setting is valid only for Power vs Resource Block and EVM vs Resource Block.

■ Setting range

Starting Subframe Number to (Starting Subframe Number + Measurement Interval – 1)

 3.6.1.1 “Analysis Time”

Slot Number

■ Summary

Sets the slot number displayed in PDSCH Constellation and Bottom Graph.

Notes:

- This is displayed when Virtual Resource Block type is Distributed.
- This setting applies to both Constellation and Bottom Graph.

■ Setting range

Starting Subframe Number × 2
to (Starting Subframe Number + Measurement Interval) × 2 – 1

Resource Block Number

■ Summary

Sets the resource block number to be displayed for Constellation and Bottom Graph.

Note:

This setting is enabled only for Power vs Resource Block and EVM vs Resource Block.

■ Setting range

| | |
|---------|----------------------------|
| 0 to 99 | Channel Bandwidth: 20 MHz |
| 0 to 74 | Channel Bandwidth: 15 MHz |
| 0 to 49 | Channel Bandwidth: 10 MHz |
| 0 to 24 | Channel Bandwidth: 5 MHz |
| 0 to 14 | Channel Bandwidth: 3 MHz |
| 0 to 5 | Channel Bandwidth: 1.4 MHz |

 3.5 “Common Setting Function Menu”

Peak Search

■ Summary

Moves the marker to the maximum level point within the measurement range. When there are multiple maximum level points, the point corresponding to the smallest value (left side of the scale) on the horizontal axis (Subcarrier, Symbol, or Resource Block) is selected.

Note:

When Trace Mode is set to Power vs Resource Block (Overall) and there are multiple maximum level points, the point corresponding to the smallest values on the horizontal and vertical (Subframe) axes is selected.

Next Peak

■ Summary

Moves the marker to the next largest level point after the current marker level within the measurement range. When there are multiple points, the point corresponding to the smallest value (left side of the scale) on the horizontal axis is selected. However, if the point is the same value as the marker level, the marker is moved to the next maximum point to the horizontal axis position of the marker.

Note:

When Trace Mode is set to Power vs Resource Block (Overall), the point corresponding to the smallest values on the horizontal and vertical axes is selected.

Dip Search

■ Summary

Moves the marker to the minimum level position within the measurement range. When there are multiple minimum level points, the greatest point (right side of the scale) on the horizontal axis is selected.

Note:

When Trace Mode is set to Power vs Resource Block (Overall) and there are multiple minimum level points, the greatest point on the horizontal axis and vertical axis is selected.

Next Dip

■ Summary

Moves the marker to the minimum level point next to the current marker level within the measurement range. When there are multiple points, the greatest point (right side of the scale) on the horizontal axis is selected. However, if the point is the same value as the marker level, the marker is moved to the next minimum point to the horizontal axis position of the marker.

Note:

When Trace Mode is set to Power vs Resource Block (Overall), the greatest point on the horizontal axis and vertical axis is selected.

3.8 Setting Trigger

Configure the trigger settings in the Trigger function menu that is displayed by pressing  (Trigger) on the main function menu or

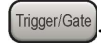

Note :

You cannot set a trigger when the Replay function is executed.



Trigger Switch

■ Summary

Sets the trigger synchronization On/Off.

■ Selection options

- | | |
|-----|--------------------------------|
| On | Enables the trigger function. |
| Off | Disables the trigger function. |

Trigger Source

■ Summary

Sets the trigger source.

■ Selection options

- | | |
|------------------|---|
| External | Starts measurement by the trigger input from an external trigger. |
| SG Marker | Starts measurement by timing inside the Vector Signal Generator option. |
| Wide IF Video | An IF signal with a wide passing band of about 50 MHz or greater is detected, and waveform capture starts in synchronization with the rise or fall of the detected signal. |
| Frame | This equipment-internal trigger signal is used to start waveform capturing. |
| Frame Sync Setup | Specifies the trigger start source for Frame Trigger if Frame is specified for Trigger Source/Gate Source. Pressing Frame Sync Setup displays the Frame Sync Setup function menu. |

Table 3.8-1 Frame Sync Setup Function Menu

| Position | Menu Display | Function |
|----------|----------------------|---|
| [F1] | Off | Captures waveforms according to the equipment-internal trigger signal. |
| [F2] | Wide IF Video | Captures waveforms according to the equipment-internal trigger signal. The trigger signal is resynchronized according to the Wide IF Video signal. |
| [F3] | External | Captures waveforms according to the equipment-internal trigger signal. The trigger signal is resynchronized according to an external trigger. |
| [F7] | Frame Trigger Period | Sets the generation period for the frame trigger signal. |
| [F8] | Frame Sync Offset | Sets the offset time from when a trigger signal (the equipment-internal trigger signal, Wide IF Video signal, or external trigger signal) is generated until a trigger actually occurs. |

Note:

The frame trigger is available with MS2830A. This function is not displayed in the MS269xA.

Trigger Slope

■ Summary

Sets the trigger polarity.

■ Selection options

| | |
|------|--|
| Rise | Synchronizes with rising edge of the trigger. |
| Fall | Synchronizes with falling edge of the trigger. |

Wide IF Video Trigger Level

■ Summary

Selects the trigger level for the wide IF video trigger.

■ Setting range

–60 to 50 dBm

Trigger Hold

■ Summary

Sets whether to enable or disable the function for disabling trigger input for a fixed time from when the first trigger is input until the next trigger is input.

■ Selection options

| | |
|-----|---------------------------|
| On | Enable the trigger hold. |
| Off | Disable the trigger hold. |

Trigger Hold Time

■ Summary

Sets the fixed time for the above function.

■ Setting range

0 to 1 s

Note:

The trigger hold is available with MS2830A. This function is not displayed in the MS269xA.

Trigger Delay

■ Summary

Sets the trigger delay.

■ Setting range

-2 to +2 s (When the Measure is Modulation Analysis or MIMO Summary.)

-0.5 to +0.5 s (When the Measure is Batch Measurement.)

3.9 EVM Display (Modulation Analysis)

EVM analysis results are displayed according to the storage mode setting. When setting to Off, the analysis results are displayed every time. When setting to Average, the average values of analysis results are displayed. When setting to Average & Max, the average and maximum value of analysis results are displayed.

 3.6.1.2 "Trace"

| | | Avg/Max |
|-------------------|----------|-----------|
| Frequency Error | -0.03 / | -0.23 Hz |
| | 0.000 / | 0.000 ppm |
| Output Power | -9.92 / | -9.92 dBm |
| Mean Power | -9.92 / | -9.92 dBm |
| Total EVM (rms) | 0.26 / | 0.26 % |
| Total EVM (peak) | 1.04 / | 1.19 % |
| Symbol Number | | 57 |
| Subcarrier Number | | 231 |
| Origin Offset | -52.82 / | -52.59 dB |
| Time Offset | -37.9 / | -37.9 ns |

Figure 3.9-1 Result window

Frequency Error

■ Summary

Displays the average frequency error in the range set in Starting Subframe Number and Measurement Interval.

 3.6.1.2 "Trace"

Output Power

■ Summary

Displays the average RF level including Cyclic Prefix in the range set in Starting Subframe Number and Measurement Interval.

Mean Power

■ Summary

Displays the mean power value including Cyclic Prefix in the bandwidth defined by Channel Bandwidth in the range set in Starting Subframe Number and Measurement Interval.

Total EVM (rms)

■ Summary

Displays the root mean square EVM of all subcarriers for the channels specified by Total EVM Calculation within the range determined by Starting Subframe Number and Measurement Interval.

Switches between % and dB according to settings of EVM Unit.

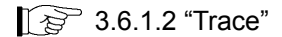

Total EVM (peak)

■ Summary

Displays the maximum EVM of all subcarriers and all symbols in the range set in Starting Subframe Number and Measurement Interval.

Switches between % and dB according to the settings of the EVM Unit.

Symbol Number

■ Summary

Displays the symbol number of Total EVM (peak).

Subcarrier Number

■ Summary

Displays the subcarrier number of Total EVM (peak).

Origin Offset

■ Summary

Displays the average origin offset in the range set in Starting Subframe Number and Measurement Interval.

Time Offset

■ Summary

Displays the time offset between the trigger input and the head of the frame.

This is enabled in the following situations:

- When the trigger function is On and when Capture Time is Auto.
- When the trigger function is On, when Capture Time is Manual, and when Storage Mode is Off
- When the Replay function is executed and when the Storage Mode is Off.

3.10 Constellation Display (Modulation Analysis)

For the MX269020A, the constellation parameters depend on the Trace Mode settings.

3.10.1 Constellation

(EVM vs Subcarrier, EVM vs Symbol, Spectral Flatness, RE Map)

The constellation in the symbol range specified by Constellation Display Range is displayed.

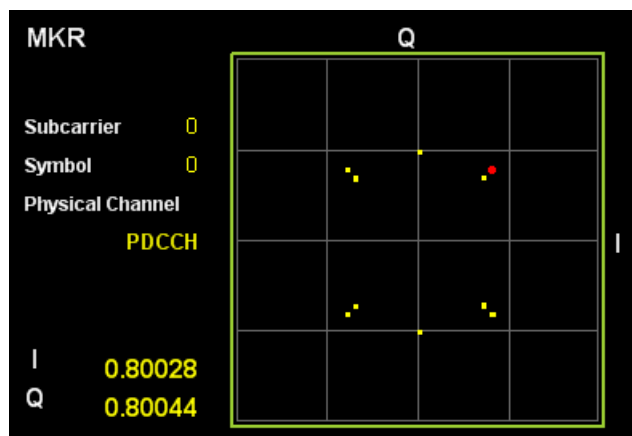

Figure 3.10.1-1 Constellation display

Graph display

■ Summary

If Constellation Display Range is Symbol, this graph displays a constellation of all subcarriers in the symbol set in Constellation Symbol Number, with it overlapped.

If Constellation Display Range is Composite, this graph displays a constellation for all subcarriers of all symbols in the range determined by Starting Subframe Number and Measurement Interval, over the other constellations.

The marker-selected subcarrier is displayed in red.

 3.6.1.2 "Trace"

MKR Subcarrier

■ Summary

Displays the marker-selected subcarrier number. The marker can be moved with the cursor key or the rotary knob.

MKR I/Q

■ **Summary**

Displays the amplitude value of I/Q of the marker-selected subcarrier. The marker can be moved with the cursor key or the rotary knob. The amplitude value is normalized in the value in which that of Reference Signal is set to 1.0.

MKR Symbol

■ **Summary**

Displays the symbol number set in Constellation Symbol Number.

MKR Physical Channel

■ **Summary**

Displays the type of physical channel for the resource element selected by the marker.

3.10.2 Constellation

(Power vs Resource Block, EVM vs Resource Block)

The PDSCH constellations specified by Subframe Number or Slot Number and Resource Block Number are displayed.

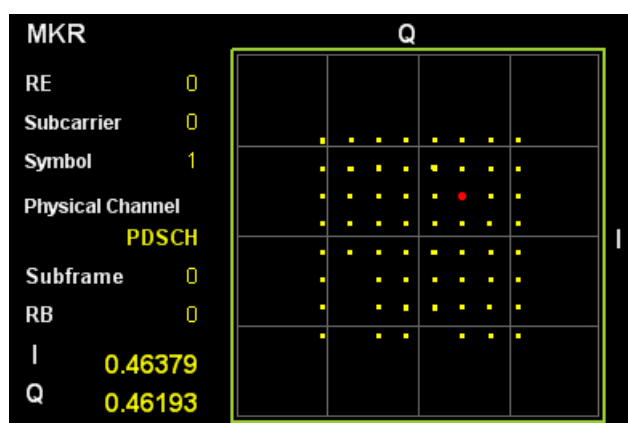

Figure 3.10.2-1 Constellation display

3

Measurement

Displaying Graph

■ Summary

Displays overlapping the constellations of all resource elements of the resource block that is determined by the Subframe Number or Slot Number and Block Number settings.

The resource element selected by the marker is displayed in red.

 3.6.1.3 “Trace”

MKR Resource Element Number

■ Summary

Displays the number of the resource element selected by the marker.

The marker can be moved by using the cursor keys or the rotary knob.

MKR Subcarrier

■ Summary

Displays the subcarrier number of the resource element selected by the marker. The marker can be moved by using the cursor keys or the rotary knob.

MKR Symbol

■ Summary

Displays the symbol number of the resource element selected by the marker. The marker can be moved by using the cursor keys or the rotary knob.

MKR I/Q

■ Summary

Displays the I/Q amplitude value of the resource element selected by the marker. The marker can be moved by using the cursor keys or the rotary knob.

The amplitude value is normalized to the value obtained by setting the amplitude value of Reference Signal to 1.0.

MKR Physical Channel

■ Summary

Displays the type of physical channel for the resource element selected by the marker.

Subframe Number

■ Summary

Displays the subframe number set by Subframe Number.

Note:

This is displayed when Virtual Resource Block Type is Localized.

Slot Number

■ Summary

Displays the slot number set by Slot Number.

Note:

This is displayed when Virtual Resource Block type is Distributed.

Resource Block Number

■ Summary

Displays the resource block number set by Resource Block Number.

3.11 EVM vs Subcarrier Display (Modulation Analysis)

EVM for each subcarrier is displayed.

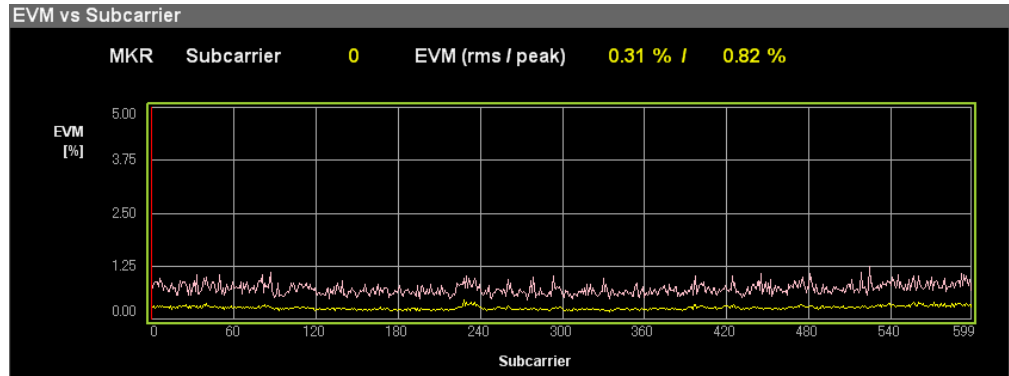



Figure 3.11-1 EVM vs Subcarrier display

Graph display

■ Summary

Displays EVM for each subcarrier. EVM for each subcarrier is based on settings of EVM vs Subcarrier View.

The marker-selected subcarrier is displayed in red.

 3.6.1.2 "Trace"

MKR Subcarrier

■ Summary

Displays the marker-selected subcarrier number. The marker can be moved with the cursor key or the rotary knob.

MKR EVM

■ Summary

Displays EVM of the marker-selected subcarrier.

The EVM value is submitted to the settings of EVM vs Subcarrier View.

MKR Symbol

■ Summary

Displays the symbol number set in EVM vs Subcarrier Symbol Number.

Note:

Displays it only when the settings of EVM vs Subcarrier View is Each Symbol.

MKR Physical Channel

■ Summary

Displays the type of physical channel for the resource element selected by the marker.

3.12 EVM vs Symbol Display (Modulation Analysis)

EVM for each Symbol is displayed.

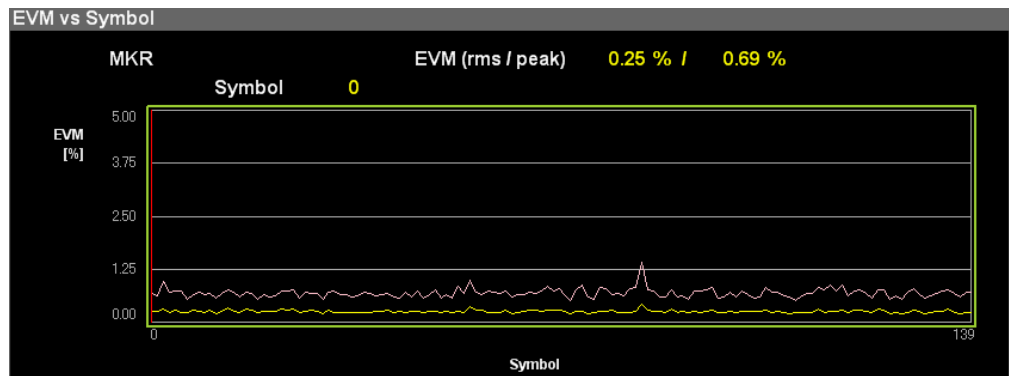



Figure 3.12-1 EVM vs Symbol display
(Averaged over Subcarriers)

Graph display

■ Summary

Displays EVM for each symbol. EVM of each symbol is based on settings of EVM vs Symbol View.

The marker-selected Subcarrier is displayed in red.

 3.6.1.2 "Trace"

MKR Symbol

■ Summary

Displays the marker-selected symbol number. The marker can be moved with the cursor key or the rotary knob.

MKR EVM

■ Summary

Displays the average EVM of all subcarriers in the marker-selected symbol. The EVM value is submitted to the settings of EVM vs Symbol View.

MKR Subcarrier

■ Summary

Displays the subcarrier number set in EVM vs Symbol Subcarrier Number.

Note:

Displays it only when the settings of EVM vs Symbol View are Each Subcarrier.

MKR Physical Channel

■ Summary

Displays the type of physical channel for the resource element selected by the marker.

3.13 Spectral Flatness Display (Modulation Analysis)

The measurement results of Spectral Flatness are displayed.

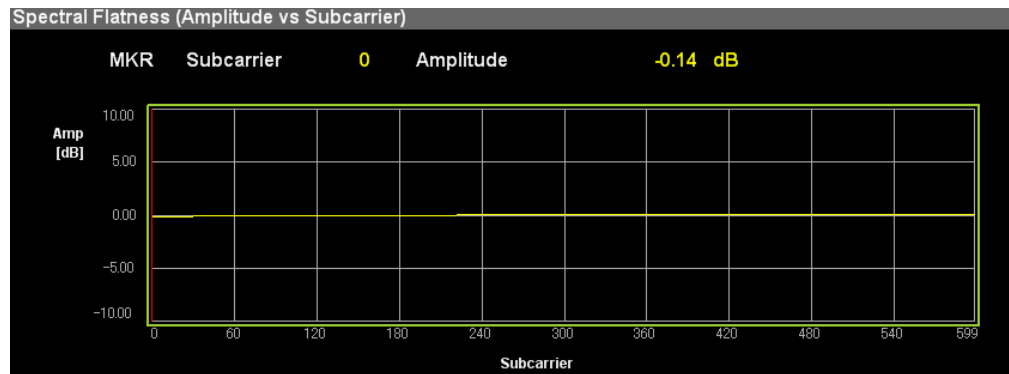

Figure 3.13-1 Amplitude of Spectral Flatness display

Graph display

■ Summary

Displays the Spectral Flatness value of an input signal. This Spectral Flatness value is based on the average in the range set in Starting Subframe Number and Measurement Interval.

The marker-selected subcarrier is displayed in red.

MKR Subcarrier

■ Summary

Displays the marker-selected subcarrier number. The marker can be moved with the cursor key or the rotary knob.

MKR Amplitude

■ Summary

Displays Amplitude of Spectral Flatness in the marker-selected subcarrier.

MKR Difference Amplitude

■ Summary

Displays the Difference Amplitude (level difference between subcarriers which are side by side) of Spectral Flatness in the marker-selected subcarrier.

MKR Phase

■ Summary

Displays the Phase of Spectral Flatness in the marker-selected subcarrier.

MKR Group Delay

■ Summary

Displays the Group Delay of Spectral Flatness in the marker-selected subcarrier.

3.14 Power vs Resource Block Display (Modulation Analysis)

Displays the PDSCH power for each resource block.

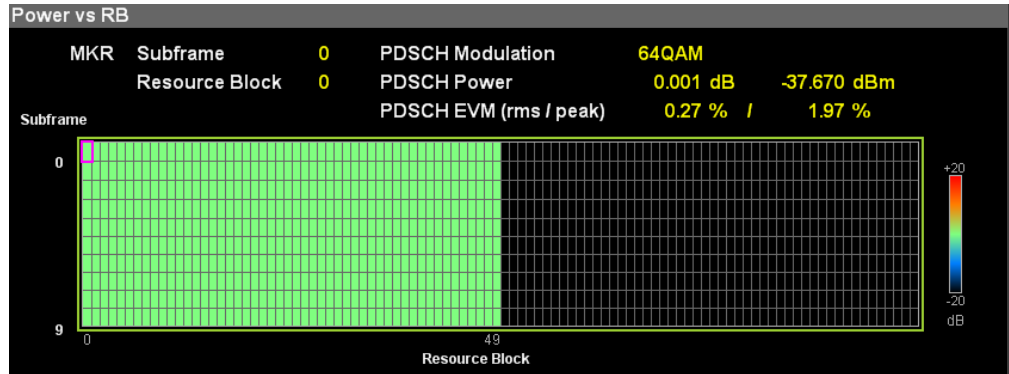

Figure 3.14-1 Power vs Resource Block display

3
Measurement

Displaying Graph

■ Summary

Displays the power for each resource block.

The resource block selected by the marker is displayed in pink.

MKR Subframe

■ Summary

Displays the number of the subframe set by Subframe Number.

Note:

This is displayed when Virtual Resource Block Type is Localized.

MKR Slot

■ Summary

Displays the slot number set by Slot Number.

Note:

This is displayed when Virtual Resource Block type is Distributed.

MKR Resource Block

■ Summary

Displays the number of the resource block selected by the marker. The marker can be moved by using the cursor keys or the rotary knob.

MKR PDSCH Modulation

■ **Summary**

Displays the modulation scheme of the PDSCH resource block selected by the marker.

MKR PDSCH Power

■ **Summary**

Displays the power of the PDSCH resource block selected by the marker. dB unit is a value relative to the reference signal power.

MKR PDSCH EVM

■ **Summary**

Displays EVM of the PDSCH resource block selected by the marker. The EVM value depends on the Graph View setting.

3.15 EVM vs Resource Block Display (Modulation Analysis)

PDSCH EVM for each resource block is displayed.

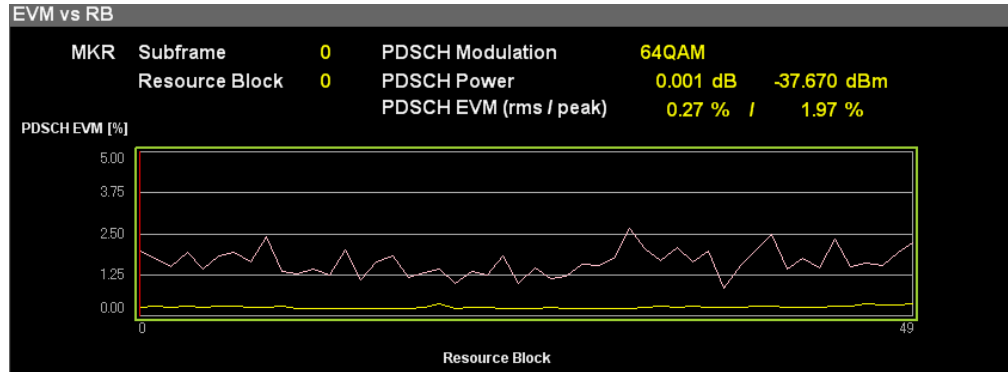

Figure 3.15-1 EVM vs Resource Block display

3

Measurement

Displaying Graph

■ Summary

Displays EVM for each resource block. EVM of each resource block depends on the Graph View setting.

The symbol selected by the marker is displayed in red.

MKR Subframe

■ Summary

Displays the number of the subframe set by Subframe Number.

Note:

This is displayed when Virtual Resource Block Type is Localized.

MKR Slot

■ Summary

Displays the slot number set by Slot Number.

Note:

This is displayed when Virtual Resource Block type is Distributed.

MKR Resource Block

■ Summary

Displays the number of the resource block selected by the marker. The marker can be moved by using the cursor keys or the rotary knob.

MKR PDSCH Modulation

■ **Summary**

Displays the modulation scheme of the PDSCH resource block selected by the marker.

MKR PDSCH Power

■ **Summary**

Displays the power of the PDSCH resource block selected by the marker. dB unit is a value relative to the reference signal power.

MKRPDSCH EVM

■ **Summary**

Displays EVM of the PDSCH resource block selected by the marker. The EVM value differs depending on the Graph View setting.

3.16 Summary Display (Modulation Analysis)

EVM and power of each channel and power of each slot are displayed.

EVM/Power of Each Channel (Page No. 1)

■ Summary

Displays the average EVM and Power of the input signal for each channel. The channels that are excluded in Detail Setting are not displayed.

Symbol Clock Error, IQ Skew, IQ Imbalance, IQ Quad Error (Page No. 1)

■ Summary

Displays the symbol clock error, IQ skew, IQ imbalance, and IQ quadrature error.

Note:

IQ skew, IQ imbalance, and IQ quad error are not displayed if Optional Measurements is Off.

EVM of Each Channel (Page No. 2 to 7)

■ Summary

Displays EVM for each channel of the input signal. The channels that are excluded in Detail Setting are not displayed.

The types of channels are as follows.

■ Channel type

Total EVM

(The channels selected by Total EVM Calculation are displayed.)

PDSCH (ALL/QPSK/16QAM/64QAM/256QAM)

PDCCH (Not displayed when Number of PDCCH is 0)

RS

SS (P-SS and S-SS)

P-SS

S-SS

PBCH

PCFICH

PHICH

DTX

Power vs Slot (Page No. 8)

■ Summary

Displays the power of each slot within the range that is determined by the Starting Subframe Number and Measurement Interval settings.

 3.6.1.1 "Analysis Time"

Power per channel (Page No. 10)

■ Summary

Displays the average power of each channel per resource element. The channels that are excluded in Detail Setting are not displayed.

If the channel is set to On and the average power of a channel is lower than -30 dB, the channel is judged to be DTX, and EVM is calculated from the ratio of the noise level to the total power.

■ Channel type

RS

P-SS

S-SS

PBCH

PDCCH (Not displayed when Number of PDCCH is 0.)

PCFICH

PHICH (PHICH group)

Cell ID (Page No. 1)

■ Summary

Displays the cell ID. It differs depending on the reference signal mode as shown in Table 3.16-1 below. This measurement result is not included for averaging.

Table 3.16-1 Results of Cell ID

| Reference Signal Mode | Cell ID |
|--|--|
| Auto | Analysis result of input signal (value of last subframe) |
| Using Cell ID | Value set for Reference Signal Cell ID |
| Load File•No file is specified (Default) | Always 0 |
| Load File•A file is specified | Not displayed |

Number of PDCCH Symbols (Page No. 1)

■ Summary

Displays the number of PDCCH Symbols. The display differs depending on the setting of PCCH On/Off and Number of PDCCH Symbols in Detail Setting as described in Table 3.16-2. This measurement result is not included for averaging.

Table 3.16-2 Results of Summary Number of PDCCH Symbols

| Detail Setting - PDCCH On/Off· Number of PDCCH Symbols | Summary - Number of PDCCH Symbols |
|--|--|
| On/Auto | Analysis result of input signal (value of last subframe) |
| On/Manual | Value set for Number of PDCCH Symbols |
| Off | Always 0 |

OFDM Symbol Tx Power (Page No. 9)

■ Summary

Displays the OFDM symbol Tx power (PDSCH power of the 4th symbol) per subframe within the range determined by Starting Subframe Number and Measurement Interval.

RS Power (Page No. 9)

■ Summary

Displays the RS power per subframe within the range determined by Starting Subframe Number and Measurement Interval.

3.17 Test Model Summary Display (Modulation Analysis)

The analysis results for the signal types set at Test Model are displayed when Test Model is not Off.

 3.5 “Common Setting Function Menu”

Page Number

■ Summary

This switches the type of results displayed in Test Model Summary.

RS boosting of each subframe (Page No. 1)

■ Summary

The RS boosting level of each subframe for the range set by Subframe Number and Measurement Interval is displayed.

EPRE of each Channel of each Subframe (Page No. 2)

■ Summary

Each channel EPRE (Energy Per Resource Element) value of each subframe for the range set by Subframe Number and Measurement Interval is displayed.

EPRE of PDSCH for each Subframe modulation method (Page No. 3)

■ Summary

The PDSCH EPRE value of each subframe for the range set by Starting Subframe Number and Measurement Interval is displayed at each modulation method.

3.18 Displaying RE Map (Modulation Analysis)

The RE Map graph shows a layout map of resource blocks and elements.

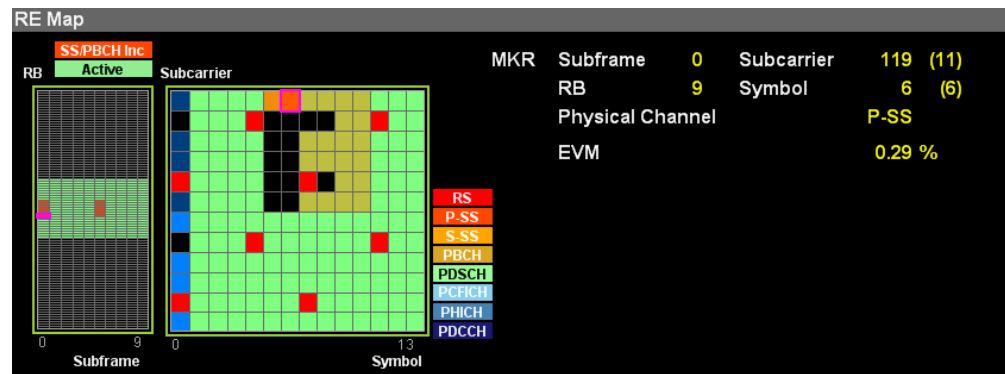

Figure 3.18-1 Displaying RE Map

Graph display

■ Summary

Displays a layout map of resource blocks (left) and resource elements (right)

In the resource block diagram on the left, each block indicates one resource block, which contains resource elements consisting of 14 symbols and 12 subcarriers. A black block indicates there is no resource block assigned. The meanings of the other block colors are shown in the color legend on the graph.

| | |
|-------------|--|
| SS/PBCH Inc | Resource blocks containing P-SS, S-SS, or PBCH |
| Active | Active resource blocks other than the above |

The layout of resource elements in the resource block selected by the marker is displayed on the right. A black block indicates that there are no resource elements assigned. The meanings of the other block colors are shown in the color legend on the graph.

MKR Subframe

■ Summary

Displays the subframe number selected by the marker in the resource block diagram.

MKR Resource Block

■ Summary

Displays the resource block number selected by the marker in the resource block diagram.

MKR Subcarrier

■ Summary

Displays the subcarrier number selected by the marker in the resource element diagram.

MKR Symbol

■ Summary

Displays the symbol number selected by the marker in the resource element diagram.

MKR Physical Channel

■ Summary

Displays the type of physical channel selected by the marker in the resource element diagram.

3.19 MIMO Summary Display

The results for each antenna port are displayed when measuring MIMO. The results are displayed for the number of antenna signals specified at Number of Antenna Ports. The Number of Antenna Ports and target measurement port are listed in Table 3.19-1).

 3.5 “Common Setting Function Menu”

Table 3.19-1 Number of Antenna ports and Target Measurement Port

| Number of Antenna Ports | Target Measurement Port |
|-------------------------|-------------------------|
| 1 | Antenna Port0 |
| 2 | Antenna Port 0, 1 |
| 4 | Antenna Port 0, 1, 2, 3 |

3

Measurement

RS Power (dB)

■ Summary

This displays the difference in the RS Power between the antenna port signal specified by Antenna Port and each antenna signal.

RS Power (dBm)

■ Summary

This displays RS Power of each antenna port signal in absolute values.

RS EVM (rms)

■ Summary

This displays the RS EVM (rms) of each antenna port signal.

RS Timing Offset

■ Summary

When Antenna is selected for Timing Offset Reference, this displays the timing difference between the antenna port signal specified by Antenna Port and each antenna port signal.

When Ext. Trigger is selected for Timing Offset Reference, this displays the timing difference between the trigger and each antenna port signal.

RS Freq

■ Summary

This displays the difference in the RS Freq between the antenna port signal specified by Antenna Port and each antenna signal.

RS Phase

■ Summary

This displays the difference in the RS Phase between the antenna port signal specified by Antenna Port and each antenna signal.

3.20 Batch Measurement Display

The batch measurement results are displayed according to the storage mode setting. When setting to Off, the analysis results are displayed every time. When setting to Average, the average values of analysis results are displayed. When setting to Average & Max, the maximum value of analysis results are displayed.

Band: Frequency Error

■ Summary

Displays the average frequency error of the CC included in Band.

Band: PDSCH EVM

■ Summary

Displays the average PDSCH EVM of the CC included in Band.

Band: Band Power

■ Summary

Displays the RF level of the Band.

When MS269xA-004/104/078/178 or MS2830A-078 are not installed, no measurement results are displayed. When MS269xA-004/104/078/178 or MS2830A-078 are installed, the measurement result of 125 MHz bandwidth is displayed.

Band: RS Power

■ Summary

Displays the average RS power value of the CC included in Band.

Band: OSTP

■ Summary

Displays the average OSTP (OFDM Symbol TX power) of the CC included in Band.

Band: OBW (Cont. CA)

■ Summary

Displays the OBW when Band Settings: Contiguous Mode is On. When the measurement bandwidth exceeds the analysis bandwidth, no measurement results are displayed.

Band: ACLR UTRA

■ Summary

Displays the ACLR UTRA. When the measurement bandwidth exceeds the analysis bandwidth, no measurement results are displayed.

Band: ACLR E-UTRA

■ Summary

Displays the ACLR E-UTRA. When the measurement bandwidth exceeds the analysis bandwidth, no measurement results are displayed.

Band: OBUE Margin

■ Summary

Displays the OBUE worst peak level relative to the standard template. When the measurement bandwidth exceeds the analysis bandwidth, no measurement results are displayed.

Band: OBUE Peak Absolute Level

■ Summary

Displays the OBUE worst peak absolute level. When the measurement bandwidth exceeds the analysis bandwidth, no measurement results are displayed.

Band: OBUE Peak Frequency

■ Summary

Displays the OBUE worst peak frequency. When the measurement bandwidth exceeds the analysis bandwidth, no measurement results are displayed.

CC: Frequency Error

■ Summary

Displays the average frequency error of the CC.

CC: PDSCH EVM

■ Summary

Displays the average PDSCH EVM of the CC.

CC: CC Power

■ Summary

Displays the average RF level of the CC.

CC: RS Power

■ Summary

Displays the RS power value of the CC.

CC: OSTP

■ Summary

Displays the OSTP of the CC.

CC: Time Offset

■ Summary

Displays the time difference between the CCs in the band. The reference is the CC with the smallest number in the band.

CC: OBW (CC)

■ Summary

Displays the OBW of the CC when Band Settings : Contiguous Mode is Off. When the measurement bandwidth exceeds the analysis bandwidth, no measurement results are displayed.

3.21 Saving Measurement Results

Save measurement results to the internal hard disk or USB memory in the Save function menu that is displayed by pressing  with the 3G LTE Downlink screen open.

Note:

Use the USB memory supplied. Other USB memory may malfunction due to incompatibilities.

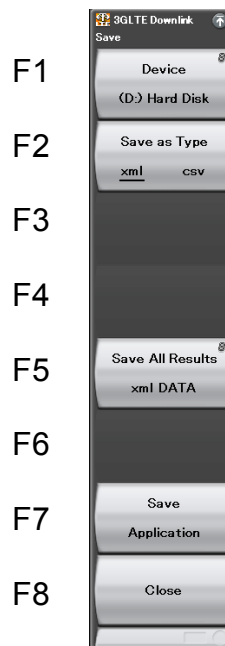



Figure 3.21-1 Save function menu

Table 3.21-1 Save function menu

| Menu Display | Function |
|------------------|---|
| Device | Sets the save destination drive. |
| Save as Type | Sets the type of the file to be saved. |
| Save All Results | Saves all results measured by the MX269020A. |
| Save Application | Sets measurement parameters.  MS2690A/MS2691A/MS2692A Signal Analyzer operation manual or MS2830A Signal Analyzer operation manual |
| Close | Closes the Save function menu. |

Device**■ Summary**

Sets the save destination drive.

■ Selection options

D, E, F, ...

All available drives except drive C

Save as Type**■ Summary**

Sets the type of the file to be saved.

■ Selection options

xml Saves in xml format.

csv Saves in csv format.

Save All Results**■ Summary**

Saves measurement results. The measurement results that can be read by the `:FETCh:EVM[n]?`, `:READ:EVM[n]?`, and `:MEASure:EVM[n]?` remote commands are saved. For details on measurement results, see Table 2.7-2 “Responses to Modulation Measurement Results” in the *MX269020A LTE Downlink Measurement Software Operation Manual (Mainframe Remote Control)*.

The saved file is output under the name format of “LTEDLdate_sequence number.xml”. When measurement results are saved several times on the same date, the sequence number starting from “00” is suffixed to each file name, like “LTEDLdate_00.xml,” “LTEDLdate_01.xml,” “LTEDLdate_02.xml,” ..., up to “LTEDdate_99.xml.”

The sequential numbers suffixed to a file name are 0 to 99. Since the file number returns to 00 after 99, files with the same name are overwritten.

Files are saved to the following directory of the target drive specified using  (Device).

The application folders are located under the following directory in the saving target drive specified by (Device).

\Anritsu Corporation\Signal Analyzer\User Data\Measurement Results\3GLTE Downlink

The maximum number of files that can be saved in a folder is 100, each for xml files and csv files.

Close

■ Summary

Closes the Save function menu.

Chapter 4 Digitize Function

This chapter describes how to save IQ data to an external memory and replay the stored IQ data.

| | | |
|-------|---|-----|
| 4.1 | Saving IQ Data..... | 4-2 |
| 4.1.1 | Format of data information file..... | 4-4 |
| 4.1.2 | Format of data file..... | 4-6 |
| 4.2 | Replay Function..... | 4-7 |
| 4.2.1 | Starting Replay Function..... | 4-8 |
| 4.2.2 | Display During Replay Function Execution ... | 4-8 |
| 4.2.3 | Restriction During Replay Function Execution..... | 4-9 |
| 4.2.4 | Conditions for IQ Data Files That Can Be Replayed..... | 4-9 |
| 4.2.5 | Stopping Replay..... | 4-9 |

4.1 Saving IQ Data

After pressing **F7** (Capture) on the Main function menu, press **F3** (Save Captured Data) to display the Save Captured Data function menu.

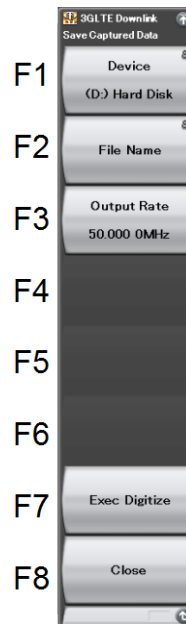

Figure 4.1-1 Save Captured Data function menu





Table 4.1-1 Save Captured Data function menu

| Menu Display | Function |
|---------------|---|
| Device | Selects the location of the file to be saved. |
| File Name | Sets the name of the file to be saved. |
| Output Rate | Sets the rate of the output data. |
| Exec Digitize | Executes saving. |
| Close | Closes the Save Captured Data function menu. |

The IQ data stored in the internal memory at the time of execution of this function is saved to the external memory.

Example: To save IQ data

<Procedure>

1. Press  (Capture) on the main function menu.
2. Press  (Save Captured Data).
3. Press  (Device) on the Save Captured Data function menu to select a data file for saving the IQ data.
4. Press  (File Name) to set the file name.
5. Press  (Exec Digitize) to save the IQ data.

When save processing is executed, the following files are created.

- “[File Name].dgz” Data file (binary format)
- “[File Name].xml” Data information file (XML format)

The IQ data row is saved to the data file. The information on the saved data is saved to the data information file.

If a file name was not specified, the file is automatically named “Digitize *date_sequential number*”. The sequential number range is from 000 to 999.

Files are saved to the following directory of the target drive specified using  (Device).

\Anritsu Corporation\Signal Analyzer\User Data\Digitized
Data\3GLTE Downlink

Up to 1000 files can be saved in a folder.

4.1.1 Format of data information file

The information on the saved IQ data is recorded in the data information file. Table 4.1.1-1 shows the details of the recorded parameters.

Table 4.1.1-1 Format of data information file

| Item | Descriptions |
|---------------------|--|
| CaptureDate | Day/Month/Year of the captured data in the “DD/MM/YYYY” format. |
| CaptureTime | Data captured time in “HH/MM/SS” format |
| FileName | Data file name |
| Format | Data format, fixed to “Float” |
| CaptureSample | Number of samples of the recorded data [Sample] |
| Condition | Error status of the recorded data “Normal”: No error “OverLoad”: Level over |
| TriggerPosition | Trigger occurrence position [Sample] The start point of the recorded data is 0. |
| CenterFrequency | Center frequency [Hz] |
| SpanFrequency | Frequency span [Hz] |
| SamplingClock | Sampling rate [Hz] |
| PreselectorBandMode | Frequency band switch mode “Normal”: Normal mode (fixed) |
| ReferenceLevel | Reference level [dBm] Note that this value does not include the reference level offset. |
| AttenuatorLevel | Attenuator value [dB] |
| InternalGain | Internal gain value [dB] This is an internal parameter. |
| PreAmp | Gain value obtained by 6 GHz PreAmp [dB] |
| IQReverse | IQ reverse setting, fixed to “Normal” |
| TriggerSwitch | Trigger On/Off setting “FreeRun”:Trigger is not used “Triggered”:Trigger is used |

Table 4.1.1-1 Format of data information file (Cont'd)

| Item | Descriptions |
|-----------------------|--|
| TriggerSource | Trigger source “External”: External trigger “SGMarker”: SG marker trigger “WideIF”: Wide IF video trigger “Frame”: Frame trigger |
| TriggerLevel | Trigger level [dBm] Note that this value does not include the reference level offset. It is in dBm units, even if the scale mode is Lin. |
| TriggerDelay | Trigger delay time [s] It is the relative time from the trigger input position to the start point of the recorded data. |
| IQReference0dBm | Reference IQ amplitude value that indicates 0 dB Fixed to “1”. |
| ExternalReferenceDisp | Reference signal information “Ref.Int”: Internal reference signal “Ref.Ext”: External reference signal “Ref.Int Unlock”: Internal reference signal is unlocked. “Ref.Ext Unlock”: External reference signal is unlocked. |
| Correction Factor | Correction value of correction function [dB] The correction factor is added to the IQ data in a data file. 0.000 is automatically set when the Correction function is set to Off. |
| Terminal | Signal input terminal “RF”: RF terminal |
| ReferencePosition | 0-second reference position Indicates the 0-second reference position using the digitized data point position. During Replay function execution, the reference position is displayed as 0 s. |
| Trigger Slope | Selects the edge where the trigger is generated (rise or fall). “Rise”: Rising edge “Fall”: Falling edge |

4.1.2 Format of data file

The data file is created in binary format. From the beginning of the file, I-phase data and Q-phase data are recorded by 4 bytes. The I-phase data and Q-phase data are recorded as a float type (IEEE real*4).

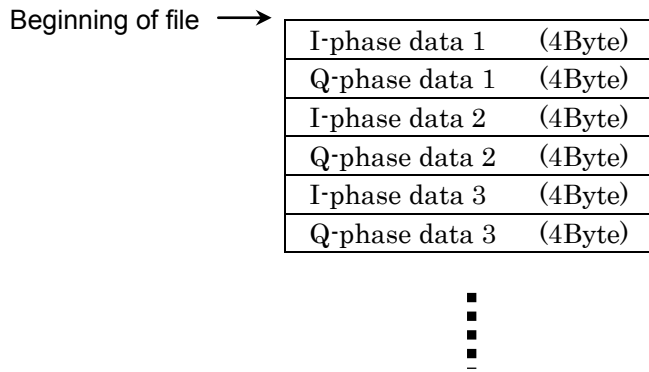

Figure 4.1.2-.1 Format of data file

The IQ data can be converted to power based on the following formula:

$$P = 10 \text{Log}_{10}(I^2 + Q^2)$$

P: Power [dBm]

I: I-phase data

Q: Q-phase data

4.2 Replay Function

The Replay function enables the saved IQ data to be reanalyzed. After pressing **F7** (Capture) on the main function menu, press **F4** (Replay) to display the Replay function menu.

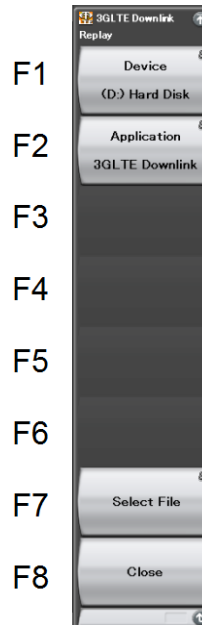

Figure 4.2-1 Replay Function Menu





Table 4.2-1 Replay Function Menu

| Menu Display | Function |
|--------------|---|
| Device | Selects the drive in which the target file is stored. |
| Application | Selects the name of the application used to save the target file. |
| Select File | Selects the target file. After selecting the file, the Replay function is executed. |
| Close | Closes the Replay function menu. |

4.2.1 Starting Replay Function

Start the Replay function using the following procedure:

<Procedure>

1. Press  (Capture) on the main function menu.
2. Press  (Replay) on the Capture function menu.
3. Press  (Device) on the Replay function menu and select the drive in which the target file is stored.
4. Press  (Application) and select the application used to save the target file.
5. Press  (Select File) to display the file selection dialog box. The Replay function starts after a file is selected. Then, **Replaying** is displayed on the screen.

Notes:

- This function is executed only for an IQ data file whose sampling rate is 50 MHz.
- Once Replay starts, the settings are initialized except for the parameters specified in Table 4.1.1-1.

4.2.2 Display During Replay Function Execution

Replay Error Info. is displayed if the target IQ data file meets the following conditions:

- Frequency reference is Unlocked when IQ data is saved.
- Level Over occurs when IQ data is saved.

4.2.3 Restriction During Replay Function Execution

The functions shown in Table 4.2.3-1 are disabled when Replay is executed.

Table 4.2.3-1 Functions Restricted During Replay

| Function |
|--------------------------|
| Center Frequency |
| Input Level |
| Pre Amp |
| Trigger Switch |
| Trigger Source |
| Trigger Slope |
| Trigger Delay |
| Wide IF Trigger Level |
| Continuous Measurement |
| Single Measurement |
| Capture Time Auto/Manual |
| Capture Time Length |
| Trigger Hold |

4.2.4 Conditions for IQ Data Files That Can Be Replayed

Table 4.2.4-1 shows the conditions for IQ data files for which replay analysis can be performed.



Table 4.2.4-1 IQ data file that can be replayed

| Name | Value |
|----------------|--|
| Format | I, Q (32-bit Float Binary format) |
| Sampling rate | 50 MHz |
| Sample numbers | More than the number equivalent to one frame Modulation Analysis: 1100000 or more ACP/OBW/Channel Power: 1230000 or more |

4.2.5 Stopping Replay

Stop the Replay function using the following procedure:

<Procedure>

1. Press  (Capture) on the main function menu.
2. Press  (Stop Replaying) to stop the Replay function.

Chapter 5 Performance Test

This chapter describes measurement devices, setup methods, and performance test procedures required for performing performance tests as preventive maintenance.

| | | |
|-------|------------------------------------|-----|
| 5.1 | Overview of Performance Test | 5-2 |
| 5.1.1 | Performance test | 5-2 |
| 5.2 | Performance Test Items | 5-3 |
| 5.2.1 | Testing methods | 5-3 |

5.1 Overview of Performance Test

5.1.1 Performance test

Performance tests are performed as part of preventive maintenance in order to prevent the performance of the MS2690A/MS2691A/MS2692A or MS2830A from being degraded before it occurs.

Use performance tests when required for acceptance inspection, routine inspection and performance verification after repairs. Perform items deemed critical at regular intervals as preventive maintenance. Perform the following performance tests for acceptance inspection, routine inspection and performance verification after repairs.

- Carrier frequency accuracy
- Residual EVM

Perform items deemed critical at regular intervals as preventive maintenance. A recommended cycle for routine tests of once or twice a year is desirable.

If items that do not meet the required level are detected during performance testing, contact an Anritsu Service and Sales office. Contact information can be found on the last page of the printed version of this manual, and is available in a separate file on the CD version.

5.2 Performance Test Items

Warm up the subject testing device and measuring instruments for at least 30 minutes except where directed, in order to stabilize them sufficiently before running performance tests. Demonstrating maximum measurement accuracy requires, in addition to the above, conducting performance tests under ambient temperatures, little AC power supply voltage fluctuations, as well as the absence of noise, vibrations, dust, humidity or other problems.

5.2.1 Testing methods

- (1) Test target standards
 - Carrier frequency accuracy
 - Residual EVM

- (2) Measuring instrument for tests
 - Vector signal generator
 - Frequency standard device Unnecessary if signal source has sufficient frequency accuracy
 - Power meter Unnecessary if signal source has sufficient transmitter power accuracy

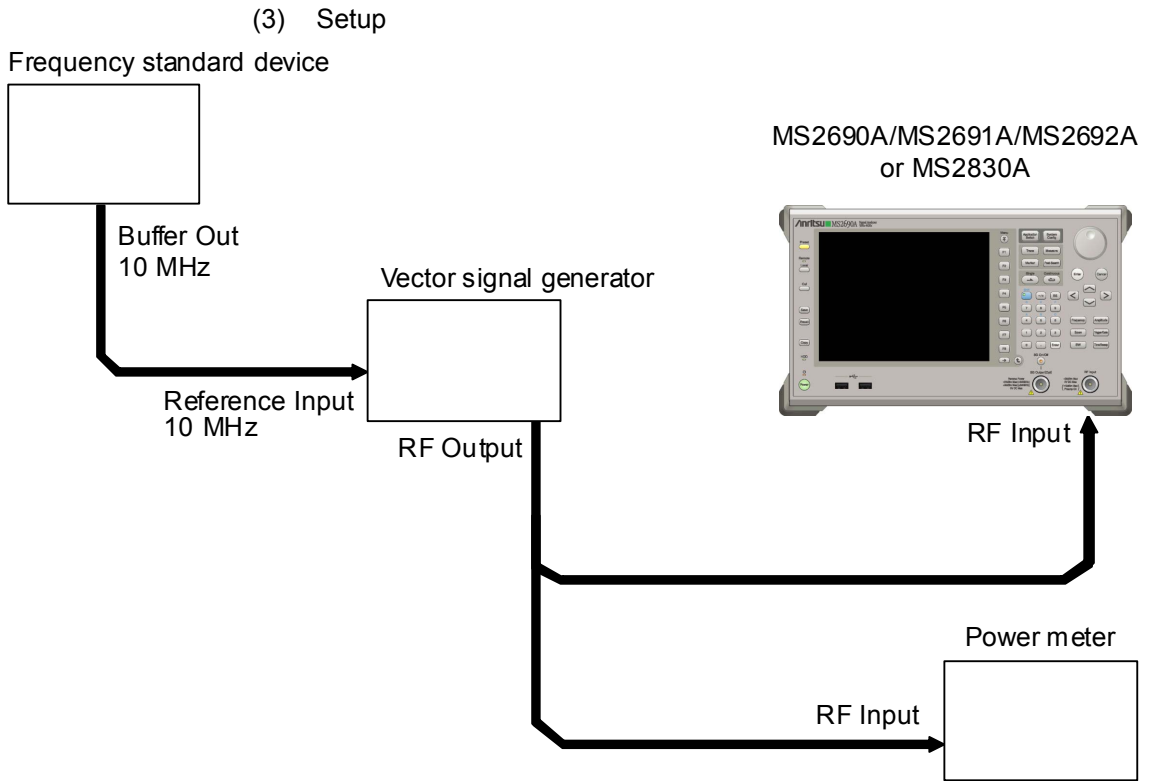

















Figure 5.2.1-1 Performance test

(4) Test procedure

(a) Signal source adjustment



1. Input the 10-MHz reference signal output from the frequency standard device into the Reference Input connector of the vector signal generator.
2. Input the 10 MHz reference signal output from the signal generator to the Reference Input connector.
3. Output an LTE Downlink modulation signal from the vector signal generator.
4. Input the vector signal generator output signal into the power meter and measure the power.

(b) Settings of the main unit

1. Turn On the power switch on the front panel then wait until the internal temperature stabilizes (approx. 1.5 hours after the temperature in the thermostatic bath stabilizes).
2. Press , then press the menu function key displaying the character string “3GLTE Downlink.”
3. Press .
4. Press  (Preset) to perform initialization.
5. Press .
6. Press  (SIGANA All) to perform calibration.
7. Press  (Close).
8. Press , enter the frequency output by the vector signal generator using the numeric keypad, then press .
9. Press , enter the power meter measurement result using the numeric keypad, then press .
10. Press  then press  (Storage) and press  (Mode) to choose Average using the cursor key or the rotary knob , then press .
11. Press  (Count), enter the measurement count, using the numeric keypad, then press .

12. Press  to measure.

When measuring the carrier frequency accuracy, select **Auto** for **Reference Signal**. When measuring the residual vector error, select **Fixed to Internal**.

Press  (System Settings) after pressing  to display the System Settings screen. Select and set Reference Signal with cursor key, and then press  (Set).

13. Confirm whether the measured Frequency Error (carrier frequency accuracy) is within the specifications.
 14. Confirm whether the measured EVM (rms) (residual vector error) value is within the specifications.

(5) Test Result

Table 5.2.1-1 Carrier frequency accuracy

| Frequency | Min. limit | Deviation (Hz) | Max. limit | Uncertainty | Pass/Fail |
|---------------------------------------|------------------------|----------------|------------------------|------------------------|-----------|
| 600 MHz | MS269xA -3 Hz | | MS269xA +3 Hz | MS269xA ±1 Hz | |
| 1500 MHz | MS2830A -3.5 Hz | | | | |
| 2000 MHz | MS2830A -3.5 Hz | | MS2830A +3.5 Hz | MS2830A ±0.5 Hz | |
| 2700 MHz | MS2830A-x78 -4.0 Hz | | | | |
| 4000 MHz 3600 MHz (MS2830A-040) | MS269xA -3 Hz | | MS269xA +3 Hz | MS269xA ±1 Hz | |
| | MS2830A -8.0 Hz | | MS2830A +8.0 Hz | MS2830A ±1.1 Hz | |
| | MS2830A-x78 -8.0 Hz | | MS2830A-x78 +8.0 Hz | MS2830A-x78 ±1.1 Hz | |

Table 5.2.1-2 Residual vector error

| Frequency | Measured value [% (rms)] | Max. limit | Uncertainty | Pass/Fail |
|---------------------------------------|--------------------------|----------------------|----------------------|-----------|
| 600 MHz | | | | |
| 1500 MHz | | | | |
| 2000 MHz | | MS269xA 1.0%(rms) | MS269xA 0.1%(rms) | |
| 2700 MHz | | MS2830A 1.3%(rms) | MS2830A 0.1%(rms) | |
| 4000 MHz 3600 MHz (MS2830A-040) | | | | |

Chapter 6 Other Functions

This chapter describes other functions of this application.

| | | |
|-----|---------------------------------|-----|
| 6.1 | Selecting Other Functions | 6-2 |
| 6.2 | Setting Title | 6-2 |
| 6.3 | Erasing Warmup Message | 6-2 |

6.1 Selecting Other Functions

Pressing  (Accessory) on the main function menu displays the Accessory function menu.





Table 6.1-1 Accessory function menu

| Function Keys | Menu Display | Function |
|---------------|-----------------------|--|
| F1 | Title | Sets the title character string. |
| F2 | Title (On/Off) | Displays (On) or hides (Off) the title character string. |
| F4 | Erase Warm Up Message | Erases the warmup message display. |

6.2 Setting Title

A title of up to 32 characters can be displayed on the screen. (Character strings of up to 17 characters can be displayed on a function menu. The maximum number of characters to be displayed on the top of the function menu varies according to character string.)



<Procedure>

1. Press  (Accessory) on the main function menu.
2. Press  (Title) to display the character string input screen. Select a character using the rotary knob, and enter it by pressing . Enter the title by repeating this operation. When the title is entered, press  (Set).
3. Press  (Title) and then select “Off” to hide the title.

6.3 Erasing Warmup Message

The warmup message , which is displayed upon power-on and indicates that the level and frequency are not stable, can be deleted.

<Procedure>

1. Press  (Accessory) on the main function menu.
2. Press  (Erase Warm Up Message) to erase the warmup message.

Appendix A Error Messages

Table A-1 Error Messages

| Message | Description |
|---|---|
| Out of range. | The settable range is exceeded. |
| Not available in RE Map Trace. | This operation is invalid when Active Trace is in the RE Map state. |
| Not available in Summary Trace. | This operation is invalid when Active Trace is in the Summary state. |
| Not available when Synchronization Mode is set to Reference Signal. | This operation is invalid when the synchronization signal is Reference Signal. |
| Not available when Synchronization Mode is set to Synchronization Signal. | This operation is invalid when the synchronization signal is Synchronization Signal. |
| Not available in 20MHz Channel Bandwidth. | This operation is invalid when Channel Bandwidth is set to 20 MHz. |
| Not available in 15MHz Channel Bandwidth. | This operation is invalid when Channel Bandwidth is set to 15 MHz. |
| Not available in 10MHz Channel Bandwidth. | This operation is invalid when Channel Bandwidth is set to 10 MHz. |
| Please Load Signal Analyzer. | The Signal Analyzer function is required to be loaded. |
| Please Load Spectrum Analyzer. | The Spectrum Analyzer function is required to be loaded. |
| No file to read. | There is no file that can be read. |
| File read error. | File reading has failed. |
| File format error. | The file format is invalid. |
| Write error. | File writing has failed. |
| Number of the letters over. | This operation is invalid because the maximum number of characters has been exceeded. |
| The model of the main instrument is different. | This operation is invalid because the specified model name does not match. |
| The option configuration is different. | This operation is invalid because the option configuration does not match. |
| File Open error. | Failed to open the specified file. |
| File Close error. | Failed to close the file. |
| Empty File Name | No character is entered. |
| Save File Limit < 100 | The save destination contains the maximum number of files (100). |
| Cannot find device. | The specified device could not be found. |
| Search error | A search error has occurred. |
| Not available when Capture Time is set to Auto. | This operation is invalid when Capture Time is set to Auto. |
| File not found. | The specified file could not be found. |
| Cannot find device. | The specified device could not be found. |
| Selected item is empty. | The selected item (file, etc.) could not be found. |
| Not available when PDCCH Mapping is Full. | This operation is invalid when PDCCH Mapping is set to Full. |

Table A-1 Error Messages (Continued)

| Message | Description |
|---|--|
| Not available when PDCCH Mapping is Load File. | This operation is invalid when PDCCH Mapping is set to Load File. |
| Available when Test Model is set to off. | This operation is valid when Test Model is set to Off. |
| Not available when PBCH is set to Off. | This operation is invalid when PBCH is set to Off. |
| Not available when P-SS is set to Off. | This operation is invalid when P-SS is set to Off. |
| Not available when S-SS is set to Off. | This operation is invalid when S-SS is set to Off. |
| Not available when PDCCH is set to Off. | This operation is invalid when PDCCH is set to Off. |
| Not available when PCFICH is set to Off. | This operation is invalid when PCFICH is set to Off. |
| Not available when PHICH is set to Off. | This operation is invalid when PHICH is set to Off. |
| Not available when Number of PDCCH Symbols in set Auto. | This operation is invalid when Number of PDCCH Symbols is set to Auto. |
| Not available when Capture Time is Manual and Capture Time Length is 1 Frame. | This operation is invalid when Capture Time is set to Manual and when Capture Time Length is set to 1 Frame. |
| Available in Using Load File Mode. | This operation is valid when Reference Signal Mode is set to Using Load File Mode. |
| Not available when Power Boosting is set to Auto. | This operation is invalid when Power Boosting is set to Auto. |
| Not available when Reference Signal Mode is set to AUTO. | — |
| Only available while replaying. | This operation is invalid when the Replay function is not executed. |
| Shortage of data samples in IQ data file. | Analysis cannot be performed because the number of data samples of the IQ data file is less than the minimum number of data samples required for analysis. |
| Unsupported SpanFrequency. | The frequency span is not supported. |
| Unsupported SamplingClock. | The sampling rate is not supported. |
| Not available if not re-capture after changing common parameter. | This operation is invalid when recapture is not executed after common parameter change. |
| Not available during measurement. | This operation is invalid during measurement. |
| Invalid character | — |

Appendix B Default Value List

| | | |
|-------------------------------------|--|---------------------------|
| Frequency | | |
| Carrier Frequency | | 2.110 GHz |
| RF Spectrum | | Normal |
| Amplitude | | |
| Input Level | | -10.00 dBm |
| Pre-Amp | | Off |
| Offset | | Off |
| Offset Value | | 0.00 dB |
| Common Setting | | |
| Channel Bandwidth | | 5 MHz |
| Test Model | | Off |
| Reference Signal | | Auto |
| Reference Signal Load | | Default |
| Power Boosting | | 0.00 dB |
| Reference Signal Mode | | Auto |
| Frequency Shift | | 0 |
| Cell ID | | 0 |
| Number of Antenna Ports | | 1 |
| Antenna Port | | 0 |
| Synchronization Mode | | Synchronization Signal |
| Modulation Analysis | | |
| Analysis Time | | |
| Starting Subframe Number | | 0 |
| Measurement Interval | | 1 |
| PDSCH Modulation Scheme | | AUTO |
| Total EVM & Constellation Composite | | |
| RS/PDSCH/PBCH/P-SS/S-SS | | |
| PDCCH/PCFICH/PHICH | | Include |
| DTX | | Exclude |
| EVM Window Length | | W, 32 |
| Detail Setting | | |
| PBCH | | On, Auto, 0.000 dB |
| P-SS | | On, Auto, 0.000 dB |
| S-SS | | On, Auto, 0.000 dB |
| PDCCH | | On, Auto, 0.000 dB |
| PCFICH | | On, Auto, 0.000 dB |
| PHICH | | On, Auto, 0.000 dB |
| PDSCH | | Auto, 0.000 dB |
| PHICH Ng | | 1/6 |
| PHICH Duration | | Normal |
| Number of PDCCH Symbol | | Auto, 1 |
| PDCCH Mapping | | Auto |
| Number of PDCCHs | | 1 |

Appendix B Default Value List

| | |
|------------------------------|----------------------------------|
| PDCCH Format | 0 |
| Pseudo-Random Sequence | TS36.211 V8.3.0 (2008-05) |
| Channel Estimation | Checked |
| Moving Average Filter | 19 |
| Measurement Filter Type | Normal |
| PDSCH EVM Calculation | 3GPP |
| Virtual Resource Block Type | Localized |
| Optional Measurements | Off |
| Cyclic Prefix Mode | Normal |
| Timing Offset Reference | Antenna |
| | |
| Trace | |
| Trace Mode | EVM vs Subcarrier |
| Constellation Display Range | Symbol |
| Scale | |
| EVM Unit | % |
| EVM Scale | 5% |
| Flatness Scale | 10 dB |
| Storage | |
| Mode | Off |
| Count | 10 |
| Symbol Number | 0 Symbol |
| Subcarrier Number | 0 Subcarrier |
| EVM vs Subcarrier View | Averaged over all Symbols |
| Graph View | RMS&Peak |
| EVM vs Symbol View | Averaged over all Subcarriers |
| Graph View | RMS&Peak |
| Spectral Flatness Type | Amplitude |
| Subframe Number | 0 |
| Resource Block Number | 0 |
| Power vs Resource Block View | Overall |
| Graph View | RMS&Peak |
| Page Number | 1 |
| Marker | |
| Marker | On |
| Subcarrier Number | 0 Subcarrier |
| Symbol Number | 0 Symbol |

| | | |
|-----------------------------|--|---|
| Trigger | | |
| Trigger Switch | | Off |
| Trigger Source | | External |
| Trigger Slope | | Rise |
| Wide IF Video Trigger Level | | -20 dBm |
| Trigger Hold | | Off |
| Trigger Hold Time | | 100 μ s |
| Trigger Delay | | 0 s |
| Frame Sync Setup | | Off |
| Frame Trigger Period | | 10 ms |
| Frame Sync Offset | | 0 s |
| Accessory | | |
| Title | | On, "3GLTE Downlink" |
| Batch Settings | | |
| Common Settings | | |
| Storage Mode | | Off |
| Storage Count | | 10 |
| Starting Subframe Number | | 0 |
| Measurement Interval | | 1 |
| Band Settings | | |
| Measurement Band | | On (Band 0) Off (Band 1) Off (Band 2) |
| Carrier Frequency | | 2.140 GHz (Band 0) 1.960 GHz (Band 1) 1.8425 GHz (Band 2) |
| Input Level | | -10.00 dBm |
| Pre-Amp | | Off |
| Offset | | Off |
| Offset Value | | 0.00 dB |
| Contiguous Mode | | On |

Appendix B Default Value List

CC Settings

| | |
|--------------------------------|---|
| Measurement CC | On (CC 0) Off (CC 1) Off (CC 2) Off (CC 3) Off (CC 4) |
| Frequency Band | Band 0 |
| Frequency Offset | 0 Hz |
| Bandwidth | 5 MHz |
| Test Model | Off |
| Synchronization Mode | SS |
| Reference Signal Mode | Auto |
| Cell ID | 0 |
| CRS Power Boosting | 0.00 dB |
| CSI-RS Power Boosting | 0.00 dB |
| CRS Number of Antenna Ports | 1 |
| CRS Antenna Port | 0 |
| CSI-RS Number of Antenna Ports | 1 |
| CSI-RS Antenna Port | 15 |
| PDSCH Modulation Scheme | AUTO |
| EVM Window Length | 32 W |
| Channel Estimation | On |
| Measurement Filter Type | Normal |
| PBCH | On, Auto, 0.000 dB |
| P-SS | On, Auto, 0.000 dB |
| S-SS | On, Auto, 0.000 dB |
| PDCCH | On, Auto, 0.000 dB |
| PCFICH | On, Auto, 0.000 dB |
| PHICH | On, Auto, 0.000 dB |
| PDSCH | Auto, 0.000 dB |
| PHICH Ng | 1/6 |
| PHICH Duration | Normal |
| Number of PDCCH Symbol | Auto, 1 |
| CSI-RS | On |
| CSI-RS Configuration | 0 |
| CSI-RS Periodicity T | 5 |
| CSI-RS Subframe Offset | 0 |

Appendix C LTE Downlink Signal Configuration

This appendix describes the configuration of the LTE Downlink signal, which is to be measured by the MX269020A.

| | | |
|-------|--|------|
| C.1 | Overview of LTE Downlink Signal..... | C-2 |
| C.2 | Details of Each Channel and Signal | C-3 |
| C.2.1 | Reference Signal | C-3 |
| C.2.2 | Synchronization Signal | C-6 |
| C.2.3 | PDSCH | C-7 |
| C.2.4 | PBCH..... | C-8 |
| C.2.5 | PDCCH..... | C-9 |
| C.2.6 | PCFICH | C-10 |
| C.2.7 | PHICH | C-10 |

C.1 Overview of LTE Downlink Signal

The MX269020A can analyze signals based on the following parameters of the 3GPP TS36.211 V8.9.0 (2009-12) Physical channels and modulation (Release 8) (hereinafter, referred to as “3GPP specifications”). Refer to the 3GPP specifications for details on the parameters.

Table C.1-1 Parameters of LTE Downlink signal

| Parameter | Setting |
|----------------------------------|---|
| Frame structure | Type 1 (FDD) |
| Physical channels | PDSCH, PBCH, PDCCH, PCFICH, PHICH |
| Physical signals | Reference signal, Synchronization signal |
| Downlink bandwidth configuration | 100 Resource Block (20 MHz bandwidth) 75 Resource Block (15 MHz bandwidth) 50 Resource Block (10 MHz bandwidth) 25 Resource Block (5 MHz bandwidth) 12 Resource Block (3 MHz bandwidth) 6 Resource Block (1.4 MHz bandwidth) |
| Cyclic prefix | Normal cyclic prefix |
| Δf | 15 kHz |
| Virtual resource block | Localized type |
| Preceding | Single antenna, transmit diversity |
| Reference signals | Cell-specific reference signals |

C.2 Details of Each Channel and Signal

As described above, the MX269020A can analyze signals configured by the PDCH, PBCH, PDCCH, PCFICH, PHICH, Reference Signal, and Synchronization Signal parameters. This section describes details of each of the channels and signals.

C.2.1 Reference Signal

Details of the Reference Signal are as follows. Depending on the Reference Signal Mode setting, the Reference Signal is switched between three types of operations. The operation of each mode is shown in Tables C.2.1-1 through C.2.1-3. The Reference Signal level is normalized to the value set by Power Boosting, to be used as the reference value for the other channels.

Table C.2.1-1 Parameters when Reference Signal Mode = Auto

| Parameter | Setting |
|--------------------------|--|
| Modulation | QPSK |
| Resource element mapping | Based on the 3GPP specifications, the Reference Signal is mapped to the resource element determined by the number of antennas and the antenna port number. The Shift Value is determined by the Cell ID that is estimated from the Synchronization Signal. |
| Symbol sequence | Value determined by the Cell ID that is estimated from the Synchronization Signal |

Table C.2.1-2 Parameters when Reference Signal Mode = Using Cell ID

| Parameter | Setting |
|--------------------------|---|
| Modulation | QPSK |
| Resource element mapping | Based on the 3GPP specifications, the Reference Signal is mapped to the resource element determined by the number of antennas and the antenna port number. The Shift Value is determined by the setting value of Cell ID. |
| Symbol sequence | Value determined by the setting value of Cell ID |

Table C.2.1-3 Parameters when Reference Signal Mode = Load File

| Parameter | Setting |
|--------------------------|--|
| Modulation | QPSK |
| Resource element mapping | Based on the 3GPP specifications, the Reference Signal is mapped to the resource element determined by the number of antennas, the antenna port number, and Shift Value. |
| Symbol sequence | Value defined by external file |

External files in the format described below are valid.

- Number of rows is either 8,800 or 4,400 rows.
- Each row, I-phase amplitude value, and Q-phase amplitude value are listed separated by a comma.
- The first row indicates the IQ map of the reference signal with the smallest symbol number and smallest subcarrier number.
- The second row indicates the IQ map of the reference signal with the smallest symbol number and the second smallest subcarrier number.
- The row following the smallest symbol number and greatest subcarrier number indicates the IQ map of the second smallest symbol number and smallest subcarrier number.
- The sum of the squares for each row is normalized to be 1.0.
- The demodulation mode of the IQ map is QPSK.
- For antenna ports 2 and 3, the latter 4,400 rows are not used.
- The default format is the same as the case when Cell ID = 0.

Table C.2.1-4 shows an example when the antenna port number and Frequency Shift are both set to 0.

Table C.2.1-4 External file example for Reference Signal

| Row No. | IQ Map of Reference Signal |
|----------------|--|
| Row 1 | Reference Signal when subframe = 0, Symbol = 0, Subcarrier = 0 |
| Row 2 | Reference Signal when subframe = 0, Symbol = 0, Subcarrier = 6 |
| Row 3 | Reference Signal when subframe = 0, Symbol = 0, Subcarrier = 12 |
| : | : |
| Row 220 | Reference Signal when subframe = 0, Symbol = 0, Subcarrier = 1314 |
| Row 221 | Reference Signal when subframe = 0, Symbol = 4, Subcarrier = 3 |
| Row 222 | Reference Signal when subframe = 0, Symbol = 4, Subcarrier = 9 |
| : | : |
| Row 440 | Reference Signal when subframe = 0, Symbol = 4, Subcarrier = 1317 |
| Row 441 | Reference Signal when subframe = 0, Symbol = 7, Subcarrier = 0 |
| : | : |
| Row 880 | Reference Signal when subframe = 0, Symbol = 11, Subcarrier = 1317 |
| Row 881 | Reference Signal when subframe = 1, Symbol = 0, Subcarrier = 0 |
| : | : |
| Row 8798 | Reference Signal when subframe = 9, Symbol = 11, Subcarrier = 1305 |
| Row 8799 | Reference Signal when subframe = 9, Symbol = 11, Subcarrier = 1311 |
| Row 8800 | Reference Signal when subframe = 9, Symbol = 11, Subcarrier = 1317 |

C.2.2 Synchronization Signal

Details of the Synchronization Signal are as follows. Depending on the Primary/Secondary Synchronization Signal On/Off setting, the Synchronization Signal is switched between two types of operations.

Table C.2.2-1 Parameters when Primary/Secondary Synchronization Signal is set to On

| Parameter | Setting |
|--------------------------|--|
| Modulation | Set according to 3GPP specifications. |
| Resource element mapping | Set according to 3GPP specifications. |
| Symbol sequence | Set based on Cell ID estimated according to 3GPP specifications. |
| Reference level | Reference Signal Level – Power Boosting |

Table C.2.2-2 Parameter when Primary/Secondary Synchronization Signal is set to Off

| Parameter | Setting |
|--------------------------|--|
| Modulation | Transmission off (DTX) |
| Resource element mapping | Set according to 3GPP specifications. |
| Symbol sequence | Resource element to which Synchronization Signal is mapped is regarded as DTX. |
| Reference level | Off |

C.2.3 PDSCH

Details of PDSCH are as follows. Depending on whether Modulation Scheme is set to Auto or other than Auto, operation is performed in two different ways. The modulation mode and reference level are estimated every subframe. When PDCH is set to other than Auto, all PDSCHs are analyzed in the specified modulation mode.

Table C.2.3-1 Parameters when PDSCH Modulation Scheme is Auto

| Parameter | Setting |
|--------------------------|--|
| Modulation | Automatically judged for each resource block. |
| Resource element mapping | Set according to 3GPP specifications. |
| Reference level | Automatically estimated for each resource block. |

Table C.2.3-2 Parameters when PDSCH Modulation Scheme is other than Auto

| Parameter | Setting |
|--------------------------|---|
| Modulation | Set according to the modulation mode setting value. |
| Resource element mapping | Set according to 3GPP specifications. |
| Reference level | Reference Signal Level – Power Boosting |

C.2.4 PBCH

Details of PBCH are as follows. Depending on the PBCH On/Off setting, operation is performed in two different ways.

Table C.2.4-1 Parameters when PBCH is set to On

| Parameter | Setting |
|--------------------------|---|
| Modulation | QPSK |
| Resource element mapping | Set according to 3GPP specifications. |
| Reference level | Reference Signal Level – Power Boosting |

Table C.2.4-2 Parameters when PBCH is set to Off

| Parameter | Setting |
|--------------------------|---------------------------------------|
| Modulation | Transmission off (DTX) |
| Resource element mapping | Set according to 3GPP specifications. |
| Reference level | Off |

C.2.5 PDCCH

Details of PDCCH are as follows. Depending on the PDCCH On/Off setting, operation is performed in two different ways.

Table C.2.5-1 Parameters when PDCCH is set to On and Number of PDCCH is 1 or more.

| Parameter | Setting |
|--------------------------|---|
| Modulation | QPSK |
| Resource element mapping | Set according to 3GPP specifications. |
| Reference Level | Reference Signal Level – Power Boosting |

Table C.2.5-2 Parameters when PDCCH is set to Off or Number of PDCCH is 0

| Parameter | Setting |
|--------------------------|---|
| Modulation | QPSK |
| Resource element mapping | Set according to 3GPP specifications. |
| Reference Level | Reference Signal Level – Power Boosting |

C.2.6 PCFICH

Details of PCFICH are as follows. Depending on the PCFICH On/Off setting, operation is performed in two different ways.

Table C.2.6-1 Parameters when PCFICH is set to On.

| Parameter | Setting |
|--------------------------|---|
| Modulation | QPSK |
| Resource element mapping | Set according to 3GPP specifications. |
| Reference Level | Reference Signal Level – Power Boosting |

Table C.2.6-2 Parameters when PCFICH is set to Off.

| Parameter | Setting |
|--------------------------|---------------------------------------|
| Modulation | Transmission Off (DTX) |
| Resource element mapping | Set according to 3GPP specifications. |
| Reference Level | Off |

C.2.7 PHICH

Details of PHICH are as follows. Depending on the PHICH On/Off setting, operation is performed in two different ways.

Table C.2.7-1 Parameters when PHICH is set to On.

| Parameter | Setting |
|--------------------------|---|
| Modulation | BPSK |
| Resource element mapping | Set according to 3GPP specifications. |
| Reference Level | Reference Signal Level – Power Boosting |

Table C.2.7-2 Parameters when PHICH is set to Off.

| Parameter | Setting |
|--------------------------|---------------------------------------|
| Modulation | Transmission Off (DTX) |
| Resource element mapping | Set according to 3GPP specifications. |
| Reference Level | Off |

References are to section numbers.

A

| | |
|--------------------|----------------|
| Accessory | 3.1.2, 6.1 |
| AC inlet | 2.1.2 |
| ACP | 3.6.3 |
| Amplitude | 3.1.2, 3.3 |
| Analysis Time | 3.6.1, 3.6.1.1 |
| Application key | 2.1.1 |
| Application Switch | 2.3.2 |
| AUX connector | 2.1.2 |

B

| | |
|----------------------------|-------|
| Bottom Graph Select | 3.7 |
| Bottom Graph Marker Number | 3.7 |
| Buffer Out connector | 2.1.2 |

C

| | |
|-----------------------------|-------------|
| Calibration | 2.4.2 |
| Cal key | 2.1.1 |
| Cancel key | 2.1.1 |
| Carrier Frequency | 3.2 |
| Channel Bandwidth | 3.5, 3.6.1 |
| Channel Estimation | 3.6.1 |
| Channel Power | 3.6.4 |
| Common Setting | 3.1.2, 3.5 |
| Constellation Marker Number | 3.7 |
| Constellation | 3.1.1, 3.10 |
| Constellation Select | 3.7 |
| Constellation Symbol Number | 3.6.1.2 |
| Continuous | 3.1.3 |
| Copy key | 2.1.1 |
| Count | 3.6.1.2 |
| Cursor key | 2.1.1 |

D

| | |
|----------------|-------|
| Detail Setting | 3.6.1 |
|----------------|-------|

E

| | |
|---------------------------------|---------------|
| Enter key | 2.1.1 |
| Erase Warm Up Message | 6.3 |
| Ethernet | 2.1.1 |
| Ethernet connector | 2.1.2 |
| EVM vs Resource Block | 3.6.1.3, 3.15 |
| EVM vs Subcarrier | 3.6.1.2, 3.11 |
| EVM vs Subcarrier View | 3.6.1.2 |
| EVM vs Symbol | 3.6.1.2, 3.12 |
| EVM vs Symbol Subcarrier Number | 3.6.1.2 |
| EVM vs Symbol View | 3.6.1.2 |
| EVM Window Length | 3.6.1 |

F

| | |
|-----------------|------------|
| Frequency | 3.1.2, 3.2 |
| Frequency Error | 3.9 |
| Function keys | 2.1.1 |
| Function menu | 3.1.2 |

G

| | |
|----------------|------------------|
| GPIB | 2.1.1 |
| GPIB connector | 2.1.2 |
| Graph View | 3.6.1.2, 3.6.1.3 |
| Graph window | 3.1.1 |

H

| | |
|-----------------------|-------|
| Hard disk access lamp | 2.1.1 |
| HDD slot | 2.1.2 |

I

| | |
|------------------|-------|
| IF Out connector | 2.1.2 |
|------------------|-------|

L

| | |
|-------------------------|-------|
| Load Application Select | 2.3.1 |
| Local key | 2.1.1 |

Index

M

| | |
|--------------------------|------------------|
| Main function keys | 2.1.1 |
| Marker | 3.1.2, 3.7 |
| Measure | 3.1.2, 3.6 |
| Measurement Interval | 3.6.1.1 |
| Measurement parameter | 3.1.1 |
| MKR Amplitude | 3.13 |
| MKR Difference Amplitude | 3.13 |
| MKR EVM | 3.11, 3.12 |
| MKR Group Delay | 3.13 |
| MKR I/Q | 3.10 |
| MKR Phase | 3.13 |
| MKR Subcarrier | 3.10, 3.11, 3.13 |
| MKR Symbol | 3.12 |
| Modulation Analysis | 3.6.1 |
| Modulation control key | 2.1.1 |
| Monitor Out connector | 2.1.2 |

N

| | |
|----------------|-------|
| Numeric keypad | 2.1.1 |
|----------------|-------|

O

| | |
|--------------|-------|
| OBW | 3.6.5 |
| Offset | 3.3 |
| Offset Value | 3.3 |

P

| | |
|-------------------------|---------------|
| Page Number | 3.6.1.4 |
| PDSCH Modulation Scheme | 3.6.1 |
| Power Boosting | 3.5 |
| Power Switch | 2.1.1 |
| Power vs Resource Block | 3.6.1.3, 3.14 |
| Power vs RB View | 3.6.1.3 |
| Pre-Amp | 3.3 |
| Preset | 2.4.1 |
| Preset key | 2.1.1 |

R

| | |
|----------------------------|--------------|
| Recall key | 2.1.1 |
| Ref Input connector | 2.1.2 |
| Reference frequency signal | 2.1.2 |
| Reference Signal | 3.5 |
| Reference Signal Load | 3.5 |
| Remote lamp | 2.1.1 |
| Resource Block Number | 3.6.1.3, 3.7 |
| Result window | 3.1.1, 3.9 |
| RF input connector | 2.1.1 |
| RF output connector | 2.1.1 |
| RF output control key | 2.1.1 |
| Rotary knob | 2.1.1 |

S

| | |
|----------------------------|-----------------|
| SA Trigger Input connector | 2.1.2 |
| Save All Results | 3.21 |
| Save as Type | 3.21 |
| Save key | 2.1.1 |
| Scale | 3.6.1.2 |
| SEM | 3.6.6 |
| SG Trigger Input connector | 2.1.2 |
| Shift key | 2.1.1 |
| Single | 3.1.3 |
| Spectral Flatness | 3.13 |
| Spectral Flatness Type | 3.6.1.2 |
| Spectrum Emission Mask | |
| Measurement | 3.6.5 |
| Starting Subframe Number | 3.6.1.1 |
| Status message | 3.1.1 |
| Storage | 3.6.1.2 |
| Subcarrier Number | 3.9, 3.12 |
| Subframe Number | 3.6.1.3, 3.7 |
| Summary | 3.6.1.4, 3.16 |
| Sweep Status Out connector | 2.1.2 |
| Symbol Number | 3.9, 3.10, 3.11 |

T

| | |
|-------------------------|----------------|
| Title | 6.2 |
| Trace | 3.6.1, 3.6.1.2 |
| Trace Mode | 3.6.1.2 |
| Trigger | 3.1.2, 3.8 |
| Trigger Delay | 3.8 |
| Trigger Input connector | 2.1.2 |
| Trigger signal | 2.1.2, 2.2 |
| Trigger Slope | 3.8 |
| Trigger Source | 3.8 |
| Trigger Switch | 3.8 |

U

| | |
|------------------------|--------------|
| USB | 2.1.1, 2.1.2 |
| USB connector (type A) | 2.1.1, 2.1.2 |
| USB connector (type B) | 2.1.2 |

